

R&S® TS-PSM4

High-Power Switch Module

User Manual

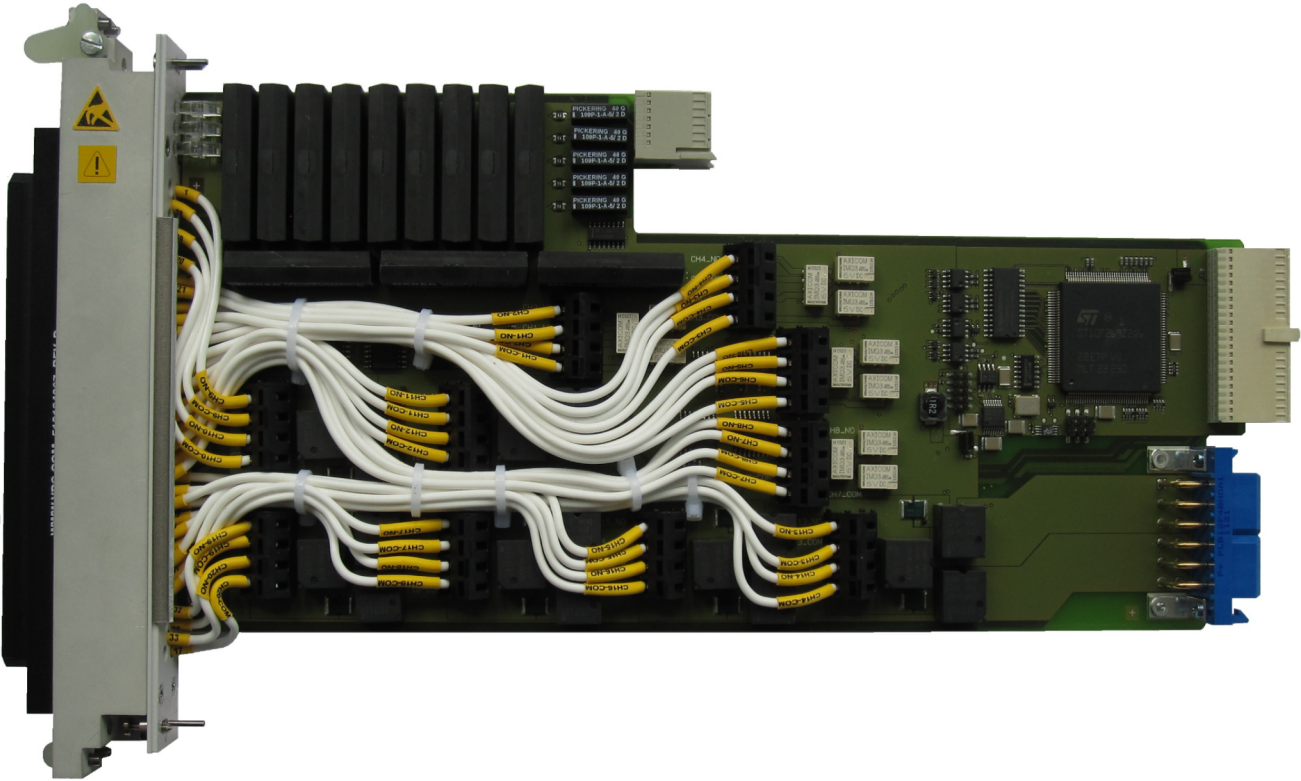

1178.2796.02 – 01

This manual describes the following R&S®TSVP models:

- R&S®TS-PSM4
- R&S®TS-PRI02

© 2016 Rohde & Schwarz GmbH & Co. KG

Mühlhofstr. 15, 81671 München, Germany

Phone: +49 89 41 29 - 0

Fax: +49 89 41 29 12 164

Email: info@rohde-schwarz.com

Internet: www.rohde-schwarz.com

Subject to change – Data without tolerance limits is not binding.

R&S® is a registered trademark of Rohde & Schwarz GmbH & Co. KG.

Trade names are trademarks of the owners.

The following abbreviations are used throughout this manual: R&S®TS-PSM4 is abbreviated as R&S TS-PSM4 and R&S®TS-PRI02 as R&S TS-PRI02.

Basic Safety Instructions

Always read through and comply with the following safety instructions!

All plants and locations of the Rohde & Schwarz group of companies make every effort to keep the safety standards of our products up to date and to offer our customers the highest possible degree of safety. Our products and the auxiliary equipment they require are designed, built and tested in accordance with the safety standards that apply in each case. Compliance with these standards is continuously monitored by our quality assurance system. The product described here has been designed, built and tested in accordance with the EC Certificate of Conformity and has left the manufacturer's plant in a condition fully complying with safety standards. To maintain this condition and to ensure safe operation, you must observe all instructions and warnings provided in this manual. If you have any questions regarding these safety instructions, the Rohde & Schwarz group of companies will be happy to answer them.



Furthermore, it is your responsibility to use the product in an appropriate manner. This product is designed for use solely in industrial and laboratory environments or, if expressly permitted, also in the field and must not be used in any way that may cause personal injury or property damage. You are responsible if the product is used for any purpose other than its designated purpose or in disregard of the manufacturer's instructions. The manufacturer shall assume no responsibility for such use of the product.

The product is used for its designated purpose if it is used in accordance with its product documentation and within its performance limits (see data sheet, documentation, the following safety instructions). Using the product requires technical skills and, in some cases, a basic knowledge of English. It is therefore essential that only skilled and specialized staff or thoroughly trained personnel with the required skills be allowed to use the product. If personal safety gear is required for using Rohde & Schwarz products, this will be indicated at the appropriate place in the product documentation. Keep the basic safety instructions and the product documentation in a safe place and pass them on to the subsequent users.











Observing the safety instructions will help prevent personal injury or damage of any kind caused by dangerous situations. Therefore, carefully read through and adhere to the following safety instructions before and when using the product. It is also absolutely essential to observe the additional safety instructions on personal safety, for example, that appear in relevant parts of the product documentation. In these safety instructions, the word "product" refers to all merchandise sold and distributed by the Rohde & Schwarz group of companies, including instruments, systems and all accessories. For product-specific information, see the data sheet and the product documentation.

Safety labels on products

The following safety labels are used on products to warn against risks and dangers.

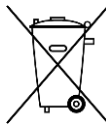
Symbol	Meaning	Symbol	Meaning
	Notice, general danger location Observe product documentation	○	ON/OFF Power
	Caution when handling heavy equipment	⏻	Standby indication
	Danger of electric shock	≡	Direct current (DC)

Basic Safety Instructions

Symbol	Meaning	Symbol	Meaning
	Caution ! Hot surface		Alternating current (AC)
	Protective conductor terminal To identify any terminal which is intended for connection to an external conductor for protection against electric shock in case of a fault, or the terminal of a protective earth		Direct/alternating current (DC/AC)
	Earth (Ground)		Class II Equipment to identify equipment meeting the safety requirements specified for Class II equipment (device protected by double or reinforced insulation)
	Frame or chassis Ground terminal		EU labeling for batteries and accumulators For additional information, see section "Waste disposal/Environmental protection", item 1.
	Be careful when handling electrostatic sensitive devices		EU labeling for separate collection of electrical and electronic devices For additional information, see section "Waste disposal/Environmental protection", item 2.
	Warning! Laser radiation For additional information, see section "Operation", item 7.		

Signal words and their meaning

The following signal words are used in the product documentation in order to warn the reader about risks and dangers.



Indicates a hazardous situation which, if not avoided, will result in death or serious injury.



Indicates a hazardous situation which, if not avoided, could result in death or serious injury.



Indicates a hazardous situation which, if not avoided, could result in minor or moderate injury.



Indicates information considered important, but not hazard-related, e.g. messages relating to property damage.

In the product documentation, the word ATTENTION is used synonymously.

These signal words are in accordance with the standard definition for civil applications in the European Economic Area. Definitions that deviate from the standard definition may also exist in other economic areas or military applications. It is therefore essential to make sure that the signal words described here are always used only in connection with the related product documentation and the related product. The use of signal words in connection with unrelated products or documentation can result in misinterpretation and in personal injury or material damage.

Basic Safety Instructions

Operating states and operating positions

The product may be operated only under the operating conditions and in the positions specified by the manufacturer, without the product's ventilation being obstructed. If the manufacturer's specifications are not observed, this can result in electric shock, fire and/or serious personal injury or death. Applicable local or national safety regulations and rules for the prevention of accidents must be observed in all work performed.

1. Unless otherwise specified, the following requirements apply to Rohde & Schwarz products: predefined operating position is always with the housing floor facing down, IP protection 2X, use only indoors, max. operating altitude 2000 m above sea level, max. transport altitude 4500 m above sea level. A tolerance of $\pm 10\%$ shall apply to the nominal voltage and $\pm 5\%$ to the nominal frequency, overvoltage category 2, pollution degree 2.
2. Do not place the product on surfaces, vehicles, cabinets or tables that for reasons of weight or stability are unsuitable for this purpose. Always follow the manufacturer's installation instructions when installing the product and fastening it to objects or structures (e.g. walls and shelves). An installation that is not carried out as described in the product documentation could result in personal injury or even death.
3. Do not place the product on heat-generating devices such as radiators or fan heaters. The ambient temperature must not exceed the maximum temperature specified in the product documentation or in the data sheet. Product overheating can cause electric shock, fire and/or serious personal injury or even death.

Electrical safety

If the information on electrical safety is not observed either at all or to the extent necessary, electric shock, fire and/or serious personal injury or death may occur.

1. Prior to switching on the product, always ensure that the nominal voltage setting on the product matches the nominal voltage of the mains-supply network. If a different voltage is to be set, the power fuse of the product may have to be changed accordingly.
2. In the case of products of safety class I with movable power cord and connector, operation is permitted only on sockets with a protective conductor contact and protective conductor.
3. Intentionally breaking the protective conductor either in the feed line or in the product itself is not permitted. Doing so can result in the danger of an electric shock from the product. If extension cords or connector strips are implemented, they must be checked on a regular basis to ensure that they are safe to use.
4. If there is no power switch for disconnecting the product from the mains, or if the power switch is not suitable for this purpose, use the plug of the connecting cable to disconnect the product from the mains. In such cases, always ensure that the power plug is easily reachable and accessible at all times. For example, if the power plug is the disconnecting device, the length of the connecting cable must not exceed 3 m. Functional or electronic switches are not suitable for providing disconnection from the AC supply network. If products without power switches are integrated into racks or systems, the disconnecting device must be provided at the system level.
5. Never use the product if the power cable is damaged. Check the power cables on a regular basis to ensure that they are in proper operating condition. By taking appropriate safety measures and carefully laying the power cable, ensure that the cable cannot be damaged and that no one can be hurt by, for example, tripping over the cable or suffering an electric shock.

Basic Safety Instructions

6. The product may be operated only from TN/TT supply networks fuse-protected with max. 16 A (higher fuse only after consulting with the Rohde & Schwarz group of companies).
7. Do not insert the plug into sockets that are dusty or dirty. Insert the plug firmly and all the way into the socket provided for this purpose. Otherwise, sparks that result in fire and/or injuries may occur.
8. Do not overload any sockets, extension cords or connector strips; doing so can cause fire or electric shocks.
9. For measurements in circuits with voltages $V_{rms} > 30$ V, suitable measures (e.g. appropriate measuring equipment, fuse protection, current limiting, electrical separation, insulation) should be taken to avoid any hazards.
10. Ensure that the connections with information technology equipment, e.g. PCs or other industrial computers, comply with the IEC 60950-1 / EN 60950-1 or IEC 61010-1 / EN 61010-1 standards that apply in each case.
11. Unless expressly permitted, never remove the cover or any part of the housing while the product is in operation. Doing so will expose circuits and components and can lead to injuries, fire or damage to the product.
12. If a product is to be permanently installed, the connection between the protective conductor terminal on site and the product's protective conductor must be made first before any other connection is made. The product may be installed and connected only by a licensed electrician.
13. For permanently installed equipment without built-in fuses, circuit breakers or similar protective devices, the supply circuit must be fuse-protected in such a way that anyone who has access to the product, as well as the product itself, is adequately protected from injury or damage.
14. Use suitable overvoltage protection to ensure that no overvoltage (such as that caused by a bolt of lightning) can reach the product. Otherwise, the person operating the product will be exposed to the danger of an electric shock.
15. Any object that is not designed to be placed in the openings of the housing must not be used for this purpose. Doing so can cause short circuits inside the product and/or electric shocks, fire or injuries.
16. Unless specified otherwise, products are not liquid-proof (see also section "Operating states and operating positions", item 1). Therefore, the equipment must be protected against penetration by liquids. If the necessary precautions are not taken, the user may suffer electric shock or the product itself may be damaged, which can also lead to personal injury.
17. Never use the product under conditions in which condensation has formed or can form in or on the product, e.g. if the product has been moved from a cold to a warm environment. Penetration by water increases the risk of electric shock.
18. Prior to cleaning the product, disconnect it completely from the power supply (e.g. AC supply network or battery). Use a soft, non-linting cloth to clean the product. Never use chemical cleaning agents such as alcohol, acetone or diluents for cellulose lacquers.

Operation

1. Operating the products requires special training and intense concentration. Make sure that persons who use the products are physically, mentally and emotionally fit enough to do so; otherwise, injuries or material damage may occur. It is the responsibility of the employer/operator to select suitable personnel for operating the products.

Basic Safety Instructions

2. Before you move or transport the product, read and observe the section titled "Transport".
3. As with all industrially manufactured goods, the use of substances that induce an allergic reaction (allergens) such as nickel cannot be generally excluded. If you develop an allergic reaction (such as a skin rash, frequent sneezing, red eyes or respiratory difficulties) when using a Rohde & Schwarz product, consult a physician immediately to determine the cause and to prevent health problems or stress.
4. Before you start processing the product mechanically and/or thermally, or before you take it apart, be sure to read and pay special attention to the section titled "Waste disposal/Environmental protection", item 1.
5. Depending on the function, certain products such as RF radio equipment can produce an elevated level of electromagnetic radiation. Considering that unborn babies require increased protection, pregnant women must be protected by appropriate measures. Persons with pacemakers may also be exposed to risks from electromagnetic radiation. The employer/operator must evaluate workplaces where there is a special risk of exposure to radiation and, if necessary, take measures to avert the potential danger.
6. Should a fire occur, the product may release hazardous substances (gases, fluids, etc.) that can cause health problems. Therefore, suitable measures must be taken, e.g. protective masks and protective clothing must be worn.
7. Laser products are given warning labels that are standardized according to their laser class. Lasers can cause biological harm due to the properties of their radiation and due to their extremely concentrated electromagnetic power. If a laser product (e.g. a CD/DVD drive) is integrated into a Rohde & Schwarz product, absolutely no other settings or functions may be used as described in the product documentation. The objective is to prevent personal injury (e.g. due to laser beams).
8. EMC classes (in line with EN 55011/CISPR 11, and analogously with EN 55022/CISPR 22, EN 55032/CISPR 32)
 - Class A equipment:
Equipment suitable for use in all environments except residential environments and environments that are directly connected to a low-voltage supply network that supplies residential buildings
Note: Class A equipment is intended for use in an industrial environment. This equipment may cause radio disturbances in residential environments, due to possible conducted as well as radiated disturbances. In this case, the operator may be required to take appropriate measures to eliminate these disturbances.
 - Class B equipment:
Equipment suitable for use in residential environments and environments that are directly connected to a low-voltage supply network that supplies residential buildings

Repair and service

1. The product may be opened only by authorized, specially trained personnel. Before any work is performed on the product or before the product is opened, it must be disconnected from the AC supply network. Otherwise, personnel will be exposed to the risk of an electric shock.

Basic Safety Instructions

- Adjustments, replacement of parts, maintenance and repair may be performed only by electrical experts authorized by Rohde & Schwarz. Only original parts may be used for replacing parts relevant to safety (e.g. power switches, power transformers, fuses). A safety test must always be performed after parts relevant to safety have been replaced (visual inspection, protective conductor test, insulation resistance measurement, leakage current measurement, functional test). This helps ensure the continued safety of the product.

Batteries and rechargeable batteries/cells

If the information regarding batteries and rechargeable batteries/cells is not observed either at all or to the extent necessary, product users may be exposed to the risk of explosions, fire and/or serious personal injury, and, in some cases, death. Batteries and rechargeable batteries with alkaline electrolytes (e.g. lithium cells) must be handled in accordance with the EN 62133 standard.

- Cells must not be taken apart or crushed.
- Cells or batteries must not be exposed to heat or fire. Storage in direct sunlight must be avoided. Keep cells and batteries clean and dry. Clean soiled connectors using a dry, clean cloth.
- Cells or batteries must not be short-circuited. Cells or batteries must not be stored in a box or in a drawer where they can short-circuit each other, or where they can be short-circuited by other conductive materials. Cells and batteries must not be removed from their original packaging until they are ready to be used.
- Cells and batteries must not be exposed to any mechanical shocks that are stronger than permitted.
- If a cell develops a leak, the fluid must not be allowed to come into contact with the skin or eyes. If contact occurs, wash the affected area with plenty of water and seek medical aid.
- Improperly replacing or charging cells or batteries that contain alkaline electrolytes (e.g. lithium cells) can cause explosions. Replace cells or batteries only with the matching Rohde & Schwarz type (see parts list) in order to ensure the safety of the product.
- Cells and batteries must be recycled and kept separate from residual waste. Rechargeable batteries and normal batteries that contain lead, mercury or cadmium are hazardous waste. Observe the national regulations regarding waste disposal and recycling.

Transport

- The product may be very heavy. Therefore, the product must be handled with care. In some cases, the user may require a suitable means of lifting or moving the product (e.g. with a lift-truck) to avoid back or other physical injuries.
- Handles on the products are designed exclusively to enable personnel to transport the product. It is therefore not permissible to use handles to fasten the product to or on transport equipment such as cranes, fork lifts, wagons, etc. The user is responsible for securely fastening the products to or on the means of transport or lifting. Observe the safety regulations of the manufacturer of the means of transport or lifting. Noncompliance can result in personal injury or material damage.
- If you use the product in a vehicle, it is the sole responsibility of the driver to drive the vehicle safely and properly. The manufacturer assumes no responsibility for accidents or collisions. Never use the product in a moving vehicle if doing so could distract the driver of the vehicle. Adequately secure the product in the vehicle to prevent injuries or other damage in the event of an accident.

Instrucciones de seguridad elementales

Waste disposal/Environmental protection

1. Specially marked equipment has a battery or accumulator that must not be disposed of with unsorted municipal waste, but must be collected separately. It may only be disposed of at a suitable collection point or via a Rohde & Schwarz customer service center.
2. Waste electrical and electronic equipment must not be disposed of with unsorted municipal waste, but must be collected separately.
Rohde & Schwarz GmbH & Co. KG has developed a disposal concept and takes full responsibility for take-back obligations and disposal obligations for manufacturers within the EU. Contact your Rohde & Schwarz customer service center for environmentally responsible disposal of the product.
3. If products or their components are mechanically and/or thermally processed in a manner that goes beyond their intended use, hazardous substances (heavy-metal dust such as lead, beryllium, nickel) may be released. For this reason, the product may only be disassembled by specially trained personnel. Improper disassembly may be hazardous to your health. National waste disposal regulations must be observed.
4. If handling the product releases hazardous substances or fuels that must be disposed of in a special way, e.g. coolants or engine oils that must be replenished regularly, the safety instructions of the manufacturer of the hazardous substances or fuels and the applicable regional waste disposal regulations must be observed. Also observe the relevant safety instructions in the product documentation. The improper disposal of hazardous substances or fuels can cause health problems and lead to environmental damage.

For additional information about environmental protection, visit the Rohde & Schwarz website.

Instrucciones de seguridad elementales

¡Es imprescindible leer y cumplir las siguientes instrucciones e informaciones de seguridad!

El principio del grupo de empresas Rohde & Schwarz consiste en tener nuestros productos siempre al día con los estándares de seguridad y de ofrecer a nuestros clientes el máximo grado de seguridad. Nuestros productos y todos los equipos adicionales son siempre fabricados y examinados según las normas de seguridad vigentes. Nuestro sistema de garantía de calidad controla constantemente que sean cumplidas estas normas. El presente producto ha sido fabricado y examinado según el certificado de conformidad de la UE y ha salido de nuestra planta en estado impecable según los estándares técnicos de seguridad. Para poder preservar este estado y garantizar un funcionamiento libre de peligros, el usuario deberá atenerse a todas las indicaciones, informaciones de seguridad y notas de alerta. El grupo de empresas Rohde & Schwarz está siempre a su disposición en caso de que tengan preguntas referentes a estas informaciones de seguridad.

Además queda en la responsabilidad del usuario utilizar el producto en la forma debida. Este producto está destinado exclusivamente al uso en la industria y el laboratorio o, si ha sido expresamente autorizado, para aplicaciones de campo y de ninguna manera deberá ser utilizado de modo que alguna persona/cosa pueda sufrir daño. El uso del producto fuera de sus fines definidos o sin tener en cuenta las instrucciones del fabricante queda en la responsabilidad del usuario. El fabricante no se hace en ninguna forma responsable de consecuencias a causa del mal uso del producto.















Instrucciones de seguridad elementales

Se parte del uso correcto del producto para los fines definidos si el producto es utilizado conforme a las indicaciones de la correspondiente documentación del producto y dentro del margen de rendimiento definido (ver hoja de datos, documentación, informaciones de seguridad que siguen). El uso del producto hace necesarios conocimientos técnicos y ciertos conocimientos del idioma inglés. Por eso se debe tener en cuenta que el producto solo pueda ser operado por personal especializado o personas instruidas en profundidad con las capacidades correspondientes. Si fuera necesaria indumentaria de seguridad para el uso de productos de Rohde & Schwarz, encontraría la información debida en la documentación del producto en el capítulo correspondiente. Guarde bien las informaciones de seguridad elementales, así como la documentación del producto, y entréguelas a usuarios posteriores.



Tener en cuenta las informaciones de seguridad sirve para evitar en lo posible lesiones o daños por peligros de toda clase. Por eso es imprescindible leer detalladamente y comprender por completo las siguientes informaciones de seguridad antes de usar el producto, y respetarlas durante el uso del producto. Deberán tenerse en cuenta todas las demás informaciones de seguridad, como p. ej. las referentes a la protección de personas, que encontrarán en el capítulo correspondiente de la documentación del producto y que también son de obligado cumplimiento. En las presentes informaciones de seguridad se recogen todos los objetos que distribuye el grupo de empresas Rohde & Schwarz bajo la denominación de "producto", entre ellos también aparatos, instalaciones así como toda clase de accesorios. Los datos específicos del producto figuran en la hoja de datos y en la documentación del producto.

Señalización de seguridad de los productos

Las siguientes señales de seguridad se utilizan en los productos para advertir sobre riesgos y peligros.

Símbolo	Significado	Símbolo	Significado
	Aviso: punto de peligro general Observar la documentación del producto		Tensión de alimentación de PUESTA EN MARCHA / PARADA
	Atención en el manejo de dispositivos de peso elevado		Indicación de estado de espera (standby)
	Peligro de choque eléctrico		Corriente continua (DC)
	Advertencia: superficie caliente		Corriente alterna (AC)
	Conexión a conductor de protección		Corriente continua / Corriente alterna (DC/AC)
	Conexión a tierra		El aparato está protegido en su totalidad por un aislamiento doble (reforzado)
	Conexión a masa		Distintivo de la UE para baterías y acumuladores Más información en la sección "Eliminación/protección del medio ambiente", punto 1.

Instrucciones de seguridad elementales

Símbolo	Significado	Símbolo	Significado
	Aviso: Cuidado en el manejo de dispositivos sensibles a la electrostática (ESD)		Distintivo de la UE para la eliminación por separado de dispositivos eléctricos y electrónicos Más información en la sección "Eliminación/protección del medio ambiente", punto 2.
	Advertencia: rayo láser Más información en la sección "Funcionamiento", punto 7.		

Palabras de señal y su significado

En la documentación del producto se utilizan las siguientes palabras de señal con el fin de advertir contra riesgos y peligros.



Indica una situación de peligro que, si no se evita, causa lesiones graves o incluso la muerte.



Indica una situación de peligro que, si no se evita, puede causar lesiones graves o incluso la muerte.



Indica una situación de peligro que, si no se evita, puede causar lesiones leves o moderadas.



Indica información que se considera importante, pero no en relación con situaciones de peligro; p. ej., avisos sobre posibles daños materiales.

En la documentación del producto se emplea de forma sinónima el término CUIDADO.

Las palabras de señal corresponden a la definición habitual para aplicaciones civiles en el área económica europea. Pueden existir definiciones diferentes a esta definición en otras áreas económicas o en aplicaciones militares. Por eso se deberá tener en cuenta que las palabras de señal aquí descritas sean utilizadas siempre solamente en combinación con la correspondiente documentación del producto y solamente en combinación con el producto correspondiente. La utilización de las palabras de señal en combinación con productos o documentaciones que no les correspondan puede llevar a interpretaciones equivocadas y tener por consecuencia daños en personas u objetos.

Estados operativos y posiciones de funcionamiento

El producto solamente debe ser utilizado según lo indicado por el fabricante respecto a los estados operativos y posiciones de funcionamiento sin que se obstruya la ventilación. Si no se siguen las indicaciones del fabricante, pueden producirse choques eléctricos, incendios y/o lesiones graves con posible consecuencia de muerte. En todos los trabajos deberán ser tenidas en cuenta las normas nacionales y locales de seguridad del trabajo y de prevención de accidentes.

Instrucciones de seguridad elementales

1. Si no se convino de otra manera, es para los productos Rohde & Schwarz válido lo que sigue: como posición de funcionamiento se define por principio la posición con el suelo de la caja para abajo, modo de protección IP 2X, uso solamente en estancias interiores, utilización hasta 2000 m sobre el nivel del mar, transporte hasta 4500 m sobre el nivel del mar. Se aplicará una tolerancia de $\pm 10\%$ sobre el voltaje nominal y de $\pm 5\%$ sobre la frecuencia nominal. Categoría de sobrecarga eléctrica 2, índice de suciedad 2.
2. No sitúe el producto encima de superficies, vehículos, estantes o mesas, que por sus características de peso o de estabilidad no sean aptos para él. Siga siempre las instrucciones de instalación del fabricante cuando instale y asegure el producto en objetos o estructuras (p. ej. paredes y estantes). Si se realiza la instalación de modo distinto al indicado en la documentación del producto, se pueden causar lesiones o, en determinadas circunstancias, incluso la muerte.
3. No ponga el producto sobre aparatos que generen calor (p. ej. radiadores o calefactores). La temperatura ambiente no debe superar la temperatura máxima especificada en la documentación del producto o en la hoja de datos. En caso de sobrecalentamiento del producto, pueden producirse choques eléctricos, incendios y/o lesiones graves con posible consecuencia de muerte.

Seguridad eléctrica

Si no se siguen (o se siguen de modo insuficiente) las indicaciones del fabricante en cuanto a seguridad eléctrica, pueden producirse choques eléctricos, incendios y/o lesiones graves con posible consecuencia de muerte.

1. Antes de la puesta en marcha del producto se deberá comprobar siempre que la tensión preseleccionada en el producto coincida con la de la red de alimentación eléctrica. Si es necesario modificar el ajuste de tensión, también se deberán cambiar en caso dado los fusibles correspondientes del producto.
2. Los productos de la clase de protección I con alimentación móvil y enchufe individual solamente podrán enchufarse a tomas de corriente con contacto de seguridad y con conductor de protección conectado.
3. Queda prohibida la interrupción intencionada del conductor de protección, tanto en la toma de corriente como en el mismo producto. La interrupción puede tener como consecuencia el riesgo de que el producto sea fuente de choques eléctricos. Si se utilizan cables alargadores o regletas de enchufe, deberá garantizarse la realización de un examen regular de los mismos en cuanto a su estado técnico de seguridad.
4. Si el producto no está equipado con un interruptor para desconectarlo de la red, o bien si el interruptor existente no resulta apropiado para la desconexión de la red, el enchufe del cable de conexión se deberá considerar como un dispositivo de desconexión. El dispositivo de desconexión se debe poder alcanzar fácilmente y debe estar siempre bien accesible. Si, p. ej., el enchufe de conexión a la red es el dispositivo de desconexión, la longitud del cable de conexión no debe superar 3 m). Los interruptores selectores o electrónicos no son aptos para el corte de la red eléctrica. Si se integran productos sin interruptor en bastidores o instalaciones, se deberá colocar el interruptor en el nivel de la instalación.
5. No utilice nunca el producto si está dañado el cable de conexión a red. Compruebe regularmente el correcto estado de los cables de conexión a red. Asegúrese, mediante las medidas de protección y de instalación adecuadas, de que el cable de conexión a red no pueda ser dañado o de que nadie pueda ser dañado por él, p. ej. al tropezar o por un choque eléctrico.

Instrucciones de seguridad elementales

6. Solamente está permitido el funcionamiento en redes de alimentación TN/TT aseguradas con fusibles de 16 A como máximo (utilización de fusibles de mayor amperaje solo previa consulta con el grupo de empresas Rohde & Schwarz).
7. Nunca conecte el enchufe en tomas de corriente sucias o llenas de polvo. Introduzca el enchufe por completo y fuertemente en la toma de corriente. La no observación de estas medidas puede provocar chispas, fuego y/o lesiones.
8. No sobrecargue las tomas de corriente, los cables alargadores o las regletas de enchufe ya que esto podría causar fuego o choques eléctricos.
9. En las mediciones en circuitos de corriente con una tensión $U_{\text{eff}} > 30 \text{ V}$ se deberán tomar las medidas apropiadas para impedir cualquier peligro (p. ej. medios de medición adecuados, seguros, limitación de tensión, corte protector, aislamiento etc.).
10. Para la conexión con dispositivos informáticos como un PC o un ordenador industrial, debe comprobarse que éstos cumplan los estándares IEC60950-1/EN60950-1 o IEC61010-1/EN 61010-1 válidos en cada caso.
11. A menos que esté permitido expresamente, no retire nunca la tapa ni componentes de la carcasa mientras el producto esté en servicio. Esto pone a descubierto los cables y componentes eléctricos y puede causar lesiones, fuego o daños en el producto.
12. Si un producto se instala en un lugar fijo, se deberá primero conectar el conductor de protección fijo con el conductor de protección del producto antes de hacer cualquier otra conexión. La instalación y la conexión deberán ser efectuadas por un electricista especializado.
13. En el caso de dispositivos fijos que no estén provistos de fusibles, interruptor automático ni otros mecanismos de seguridad similares, el circuito de alimentación debe estar protegido de modo que todas las personas que puedan acceder al producto, así como el producto mismo, estén a salvo de posibles daños.
14. Todo producto debe estar protegido contra sobretensión (debida p. ej. a una caída del rayo) mediante los correspondientes sistemas de protección. Si no, el personal que lo utilice quedará expuesto al peligro de choque eléctrico.
15. No debe introducirse en los orificios de la caja del aparato ningún objeto que no esté destinado a ello. Esto puede producir cortocircuitos en el producto y/o puede causar choques eléctricos, fuego o lesiones.
16. Salvo indicación contraria, los productos no están impermeabilizados (ver también el capítulo "Estados operativos y posiciones de funcionamiento", punto 1). Por eso es necesario tomar las medidas necesarias para evitar la entrada de líquidos. En caso contrario, existe peligro de choque eléctrico para el usuario o de daños en el producto, que también pueden redundar en peligro para las personas.
17. No utilice el producto en condiciones en las que pueda producirse o ya se hayan producido condensaciones sobre el producto o en el interior de éste, como p. ej. al desplazarlo de un lugar frío a otro caliente. La entrada de agua aumenta el riesgo de choque eléctrico.
18. Antes de la limpieza, desconecte por completo el producto de la alimentación de tensión (p. ej. red de alimentación o batería). Realice la limpieza de los aparatos con un paño suave, que no se deshilache. No utilice bajo ningún concepto productos de limpieza químicos como alcohol, acetona o diluyentes para lacas nitrocelulósicas.

Instrucciones de seguridad elementales

Funcionamiento

1. El uso del producto requiere instrucciones especiales y una alta concentración durante el manejo. Debe asegurarse que las personas que manejen el producto estén a la altura de los requerimientos necesarios en cuanto a aptitudes físicas, psíquicas y emocionales, ya que de otra manera no se pueden excluir lesiones o daños de objetos. El empresario u operador es responsable de seleccionar el personal usuario apto para el manejo del producto.
2. Antes de desplazar o transportar el producto, lea y tenga en cuenta el capítulo "Transporte".
3. Como con todo producto de fabricación industrial no puede quedar excluida en general la posibilidad de que se produzcan alergias provocadas por algunos materiales empleados —los llamados alérgenos (p. ej. el níquel)—. Si durante el manejo de productos Rohde & Schwarz se producen reacciones alérgicas, como p. ej. irritaciones cutáneas, estornudos continuos, enrojecimiento de la conjuntiva o dificultades respiratorias, debe avisarse inmediatamente a un médico para investigar las causas y evitar cualquier molestia o daño a la salud.
4. Antes de la manipulación mecánica y/o térmica o el desmontaje del producto, debe tenerse en cuenta imprescindiblemente el capítulo "Eliminación/protección del medio ambiente", punto 1.
5. Ciertos productos, como p. ej. las instalaciones de radiocomunicación RF, pueden a causa de su función natural, emitir una radiación electromagnética aumentada. Deben tomarse todas las medidas necesarias para la protección de las mujeres embarazadas. También las personas con marcapasos pueden correr peligro a causa de la radiación electromagnética. El empresario/operador tiene la obligación de evaluar y señalar las áreas de trabajo en las que exista un riesgo elevado de exposición a radiaciones.
6. Tenga en cuenta que en caso de incendio pueden desprenderse del producto sustancias tóxicas (gases, líquidos etc.) que pueden generar daños a la salud. Por eso, en caso de incendio deben usarse medidas adecuadas, como p. ej. máscaras antigás e indumentaria de protección.
7. Los productos con láser están provistos de indicaciones de advertencia normalizadas en función de la clase de láser del que se trate. Los rayos láser pueden provocar daños de tipo biológico a causa de las propiedades de su radiación y debido a su concentración extrema de potencia electromagnética. En caso de que un producto Rohde & Schwarz contenga un producto láser (p. ej. un lector de CD/DVD), no debe usarse ninguna otra configuración o función aparte de las descritas en la documentación del producto, a fin de evitar lesiones (p. ej. debidas a irradiación láser).
8. Clases de compatibilidad electromagnética (conforme a EN 55011 / CISPR 11; y en analogía con EN 55022 / CISPR 22, EN 55032 / CISPR 32)
 - Aparato de clase A:
Aparato adecuado para su uso en todos los entornos excepto en los residenciales y en aquellos conectados directamente a una red de distribución de baja tensión que suministra corriente a edificios residenciales.
Nota: Los aparatos de clase A están destinados al uso en entornos industriales. Estos aparatos pueden causar perturbaciones radioeléctricas en entornos residenciales debido a posibles perturbaciones guiadas o radiadas. En este caso, se le podrá solicitar al operador que tome las medidas adecuadas para eliminar estas perturbaciones.
 - Aparato de clase B:
Aparato adecuado para su uso en entornos residenciales, así como en aquellos conectados directamente a una red de distribución de baja tensión que suministra corriente a edificios residenciales.

Instrucciones de seguridad elementales

Reparación y mantenimiento

1. El producto solamente debe ser abierto por personal especializado con autorización para ello. Antes de manipular el producto o abrirlo, es obligatorio desconectarlo de la tensión de alimentación, para evitar toda posibilidad de choque eléctrico.
2. El ajuste, el cambio de partes, el mantenimiento y la reparación deberán ser efectuadas solamente por electricistas autorizados por Rohde & Schwarz. Si se reponen partes con importancia para los aspectos de seguridad (p. ej. el enchufe, los transformadores o los fusibles), solamente podrán ser sustituidos por partes originales. Después de cada cambio de partes relevantes para la seguridad deberá realizarse un control de seguridad (control a primera vista, control del conductor de protección, medición de resistencia de aislamiento, medición de la corriente de fuga, control de funcionamiento). Con esto queda garantizada la seguridad del producto.

Baterías y acumuladores o celdas

Si no se siguen (o se siguen de modo insuficiente) las indicaciones en cuanto a las baterías y acumuladores o celdas, pueden producirse explosiones, incendios y/o lesiones graves con posible consecuencia de muerte. El manejo de baterías y acumuladores con electrolitos alcalinos (p. ej. celdas de litio) debe seguir el estándar EN 62133.

1. No deben desmontarse, abrirse ni triturarse las celdas.
2. Las celdas o baterías no deben someterse a calor ni fuego. Debe evitarse el almacenamiento a la luz directa del sol. Las celdas y baterías deben mantenerse limpias y secas. Limpiar las conexiones sucias con un paño seco y limpio.
3. Las celdas o baterías no deben cortocircuitarse. Es peligroso almacenar las celdas o baterías en estuches o cajones en cuyo interior puedan cortocircuitarse por contacto recíproco o por contacto con otros materiales conductores. No deben extraerse las celdas o baterías de sus embalajes originales hasta el momento en que vayan a utilizarse.
4. Las celdas o baterías no deben someterse a impactos mecánicos fuertes indebidos.
5. En caso de falta de estanqueidad de una celda, el líquido vertido no debe entrar en contacto con la piel ni los ojos. Si se produce contacto, lavar con agua abundante la zona afectada y avisar a un médico.
6. En caso de cambio o recarga inadecuados, las celdas o baterías que contienen electrolitos alcalinos (p. ej. las celdas de litio) pueden explotar. Para garantizar la seguridad del producto, las celdas o baterías solo deben ser sustituidas por el tipo Rohde & Schwarz correspondiente (ver lista de recambios).
7. Las baterías y celdas deben reciclarse y no deben tirarse a la basura doméstica. Las baterías o acumuladores que contienen plomo, mercurio o cadmio deben tratarse como residuos especiales. Respete en esta relación las normas nacionales de eliminación y reciclaje.

Transporte

1. El producto puede tener un peso elevado. Por eso es necesario desplazarlo o transportarlo con precaución y, si es necesario, usando un sistema de elevación adecuado (p. ej. una carretilla elevadora), a fin de evitar lesiones en la espalda u otros daños personales.

Instrucciones de seguridad elementales

2. Las asas instaladas en los productos sirven solamente de ayuda para el transporte del producto por personas. Por eso no está permitido utilizar las asas para la sujeción en o sobre medios de transporte como p. ej. grúas, carretillas elevadoras de horquilla, carros etc. Es responsabilidad suya fijar los productos de manera segura a los medios de transporte o elevación. Para evitar daños personales o daños en el producto, siga las instrucciones de seguridad del fabricante del medio de transporte o elevación utilizado.
3. Si se utiliza el producto dentro de un vehículo, recae de manera exclusiva en el conductor la responsabilidad de conducir el vehículo de manera segura y adecuada. El fabricante no asumirá ninguna responsabilidad por accidentes o colisiones. No utilice nunca el producto dentro de un vehículo en movimiento si esto pudiera distraer al conductor. Asegure el producto dentro del vehículo debidamente para evitar, en caso de un accidente, lesiones u otra clase de daños.

Eliminación/protección del medio ambiente

1. Los dispositivos marcados contienen una batería o un acumulador que no se debe desechar con los residuos domésticos sin clasificar, sino que debe ser recogido por separado. La eliminación se debe efectuar exclusivamente a través de un punto de recogida apropiado o del servicio de atención al cliente de Rohde & Schwarz.
2. Los dispositivos eléctricos usados no se deben desechar con los residuos domésticos sin clasificar, sino que deben ser recogidos por separado.
Rohde & Schwarz GmbH & Co.KG ha elaborado un concepto de eliminación de residuos y asume plenamente los deberes de recogida y eliminación para los fabricantes dentro de la UE. Para desechar el producto de manera respetuosa con el medio ambiente, dirijase a su servicio de atención al cliente de Rohde & Schwarz.
3. Si se trabaja de manera mecánica y/o térmica cualquier producto o componente más allá del funcionamiento previsto, pueden liberarse sustancias peligrosas (polvos con contenido de metales pesados como p. ej. plomo, berilio o níquel). Por eso el producto solo debe ser desmontado por personal especializado con formación adecuada. Un desmontaje inadecuado puede ocasionar daños para la salud. Se deben tener en cuenta las directivas nacionales referentes a la eliminación de residuos.
4. En caso de que durante el trato del producto se formen sustancias peligrosas o combustibles que deban tratarse como residuos especiales (p. ej. refrigerantes o aceites de motor con intervalos de cambio definidos), deben tenerse en cuenta las indicaciones de seguridad del fabricante de dichas sustancias y las normas regionales de eliminación de residuos. Tenga en cuenta también en caso necesario las indicaciones de seguridad especiales contenidas en la documentación del producto. La eliminación incorrecta de sustancias peligrosas o combustibles puede causar daños a la salud o daños al medio ambiente.

Se puede encontrar más información sobre la protección del medio ambiente en la página web de Rohde & Schwarz.

Quality management and environmental management

Certified Quality System
ISO 9001

Certified Environmental System
ISO 14001

Sehr geehrter Kunde,

Sie haben sich für den Kauf eines Rohde&Schwarz Produktes entschieden. Sie erhalten damit ein nach modernsten Fertigungsmethoden hergestelltes Produkt. Es wurde nach den Regeln unserer Qualitäts- und Umweltmanagementsysteme entwickelt, gefertigt und geprüft. Rohde&Schwarz ist unter anderem nach den Managementsystemen ISO9001 und ISO 14001 zertifiziert.

Der Umwelt verpflichtet

- Energie-effiziente, RoHS-konforme Produkte
- Kontinuierliche Weiterentwicklung nachhaltiger Umweltkonzepte
- ISO 14001-zertifiziertes Umweltmanagementsystem

Dear customer,

You have decided to buy a Rohde&Schwarz product. This product has been manufactured using the most advanced methods. It was developed, manufactured and tested in compliance with our quality management and environmental management systems. Rohde&Schwarz has been certified, for example, according to the ISO9001 and ISO 14001 management systems.

Environmental commitment

- Energy-efficient products
- Continuous improvement in environmental sustainability
- ISO 14001-certified environmental management system

Cher client,

Vous avez choisi d'acheter un produit Rohde&Schwarz. Vous disposez donc d'un produit fabriqué d'après les méthodes les plus avancées. Le développement, la fabrication et les tests de ce produit ont été effectués selon nos systèmes de management de qualité et de management environnemental. La société Rohde&Schwarz a été homologuée, entre autres, conformément aux systèmes de management ISO 9001 et ISO 14001.

Engagement écologique

- Produits à efficience énergétique
- Amélioration continue de la durabilité environnementale
- Système de management environnemental certifié selon ISO 14001



Customer Support

Technical support – where and when you need it

For quick, expert help with any Rohde & Schwarz equipment, contact one of our Customer Support Centers. A team of highly qualified engineers provides telephone support and will work with you to find a solution to your query on any aspect of the operation, programming or applications of Rohde & Schwarz equipment.

Up-to-date information and upgrades

To keep your instrument up-to-date and to be informed about new application notes related to your instrument, please send an e-mail to the Customer Support Center stating your instrument and your wish. We will take care that you will get the right information.

Europe, Africa, Middle East

Phone +49 89 4129 12345
customersupport@rohde-schwarz.com

North America

Phone 1-888-TEST-RSA (1-888-837-8772)
customer.support@rsa.rohde-schwarz.com

Latin America

Phone +1-410-910-7988
customersupport.la@rohde-schwarz.com

Asia/Pacific

Phone +65 65 13 04 88
customersupport.asia@rohde-schwarz.com

China

Phone +86-800-810-8228 /
+86-400-650-5896
customersupport.china@rohde-schwarz.com



1 Application

1.1 General

The ROHDE & SCHWARZ High-power Switch Module R&S TS-PSM4 is intended for the R&S CompactTSVP and R&S PowerTSVP test platform. The module occupies one slot. Control of the module is via the CAN bus.

The module is available in two versions:

- It can be ordered with a connector of the Virginia Panel Corp. (VPC) on the front of the module as R&S TS-PSM4 (variant 03), order no. 1519.2622.03. The connector is connected to the individual channels of the module via terminals on the base board using a pre-assembled cable set.
- The R&S TS-PSM4B (variant 02), order no. 1519.2622.02, is delivered without VPC, the user can connect his loads or power supply units with his own cables via apertures on the front plate of the module to the terminals of the channels.

A soft panel is available for operating the R&S TS-PSM4. Control is via an IVI switch driver.

1.2 Safety advice

⚠ CAUTION

To prevent danger to the user when using hazardous voltages, the R&S CompactTSVP TS-PCA3 and R&S PowerTSVP TS-PWA3 production test platform must never be operated with an open housing or the front- or side covers opened. General safety regulations must be observed.

⚠ CAUTION

The R&S CompactTSVP and R&S PowerTSVP test platforms are principally designed for operating voltages up to 125 V. The R&S TS-PSM4 is suitable for voltages of up to +30 VDC and must only be used correspondingly. When higher currents are run through, relays and circuit board can become very hot.

NOTICE

If signals with hazardous voltages are being connected via the analogue measurement bus, all modules involved, including external PXI modules, must be specified for this voltage.

1.3 Characteristics

Table 1-1: Characteristics R&S TS-PSM4

Characteristics R&S TS-PSM4
Deployable in the R&S TS-PCA3 (R&S CompactTSVP) and R&S TS-PWA3 (R&S PowerTSVP) chassis
Control via CAN bus
Twelve high power channels for currents up to 16 A
Eight low power channels for currents up to 2 A
Switching of voltages up to 30 V
Current measurement capabilities using shunt resistors
Feed-through of all channels to the rear of the R&S TS-PWA3 chassis by means of R&S TS-PRIO2 Rear-I/O-Module possible
Feed-through of all channels to the rear of the R&S TS-PCA3 chassis by means of optional R&S TS-PK04 cable set possible
Support via R&S Signal Routing Library TS-LSRL
Self-test capability
Soft panel for interactive operation
IVI switch driver available



In permanent operation of the 16 A relays with low switching voltages and low switching currents there is a risk of an increase in the contact resistance due to a forming film on the contact surfaces. It is therefore recommended to regularly switch the contacts under load (eg. 5 A / 12 V).

Table 1-2: R&S TS-PRIO2 characteristics

R&S TS-PRIO2 characteristics
Direct routing of all low-power channels to the rear panel of the chassis R&S TS-PWA3.
Direct routing of all high-power channels to the rear panel of the chassis R&S TS-PWA3.

2 View

Figure 2-1 shows the view of the High-power Switch Module R&S TS-PSM4 (variant 03).

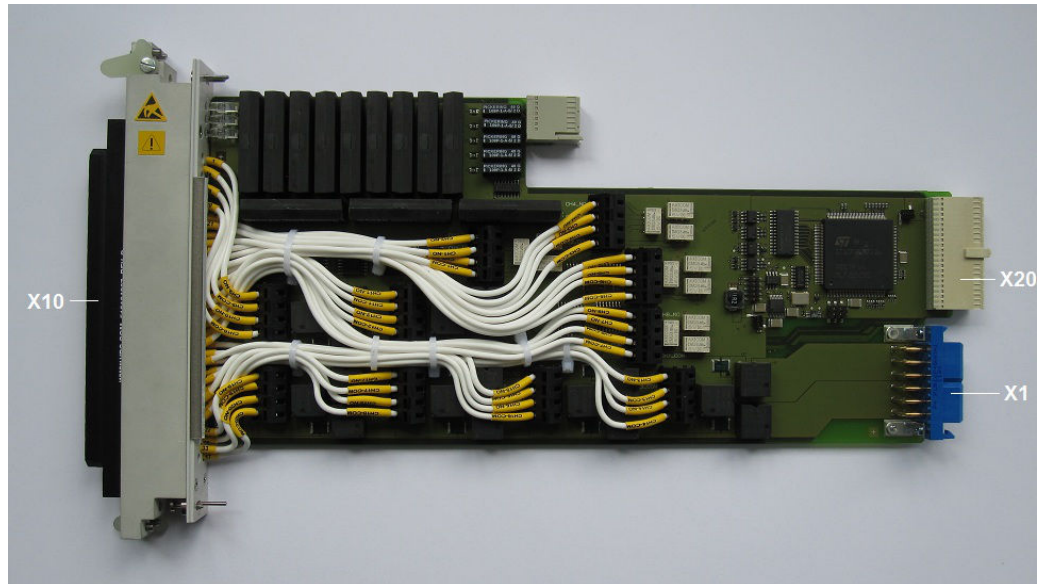

Figure 2-1: View of the R&S TS-PSM4 (variant 03)

Figure 2-2 shows the view of the High-power Switch Module R&S TS-PSM4B (variant 02).

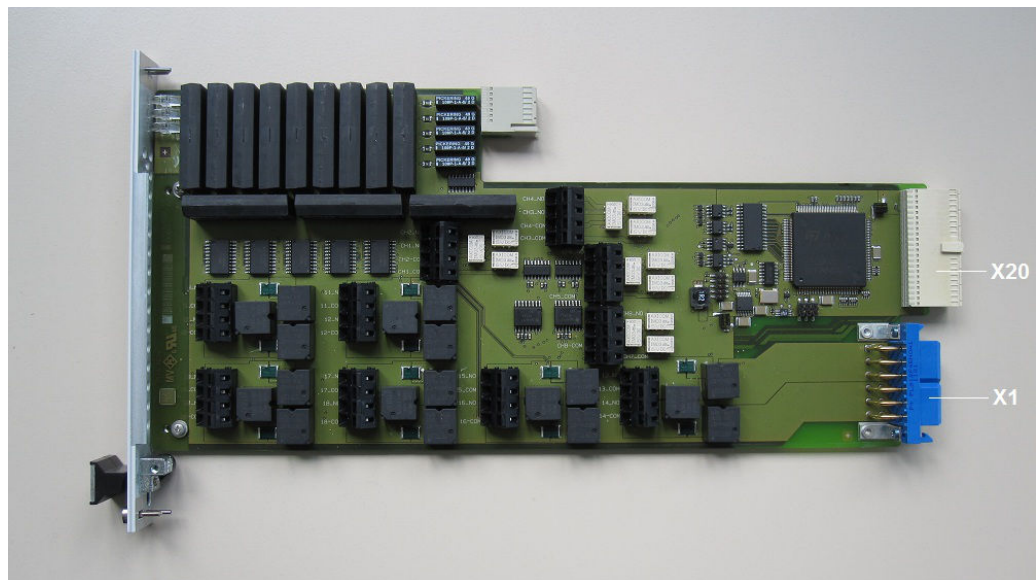

Figure 2-2: View of the R&S TS-PSM4B (variant 02)

3 Block diagram

Figure 3-1 shows the block diagram of the High-power Switch Module R&S TS-PSM4.

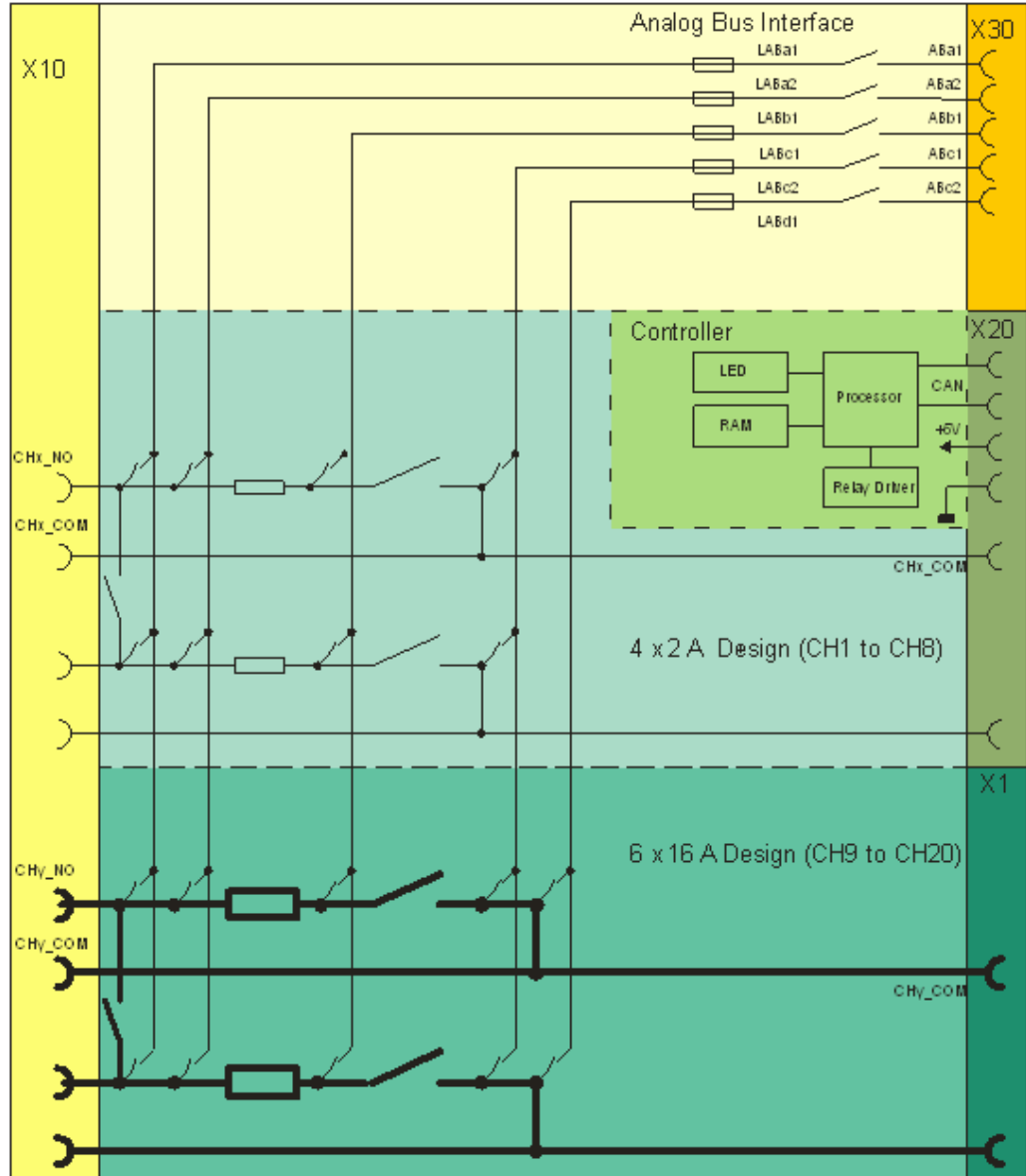

Figure 3-1: Block diagram R&S TS-PSM4

4 Construction

4.1 R&S TS-PSM4

4.1.1 Mechanical construction

The R&S TS-PSM4 module consists of a base board to which all relays and terminal blocks as well as the processor and the FRAM are attached.

The connector X10 (only R&S TS-PSM4 (variant 03)) is located on the front side of the module. The R&S TS-PSM4B (variant 02)) in contrast is supplied without this connector. On its front side, only a front plate with openings for cable entry is attached.

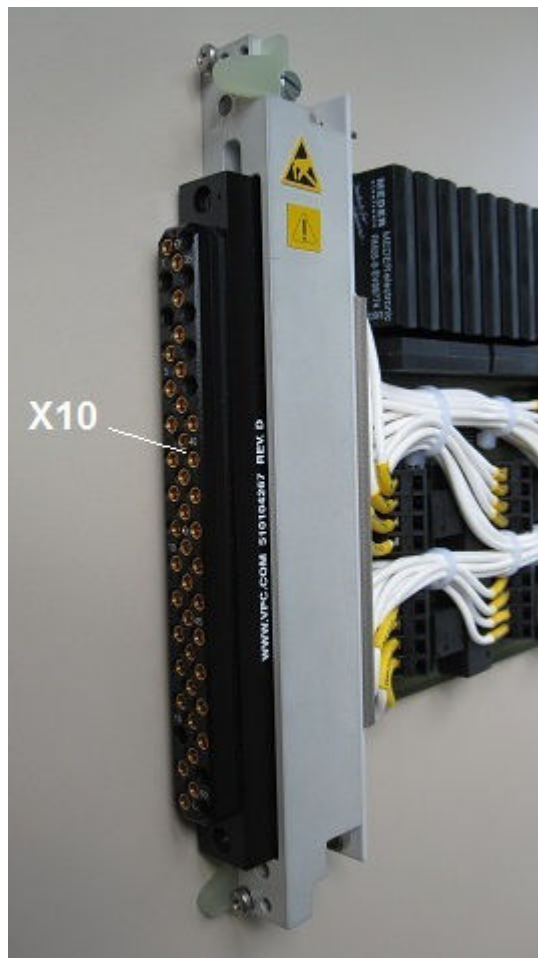

Figure 4-1: R&S TS-PSM4 (variant 03) Front with VPC

The connectors X20 and X1 are located on the rear of the module. The connector X30 is located on the upper edge of the base board in the middle of the module.

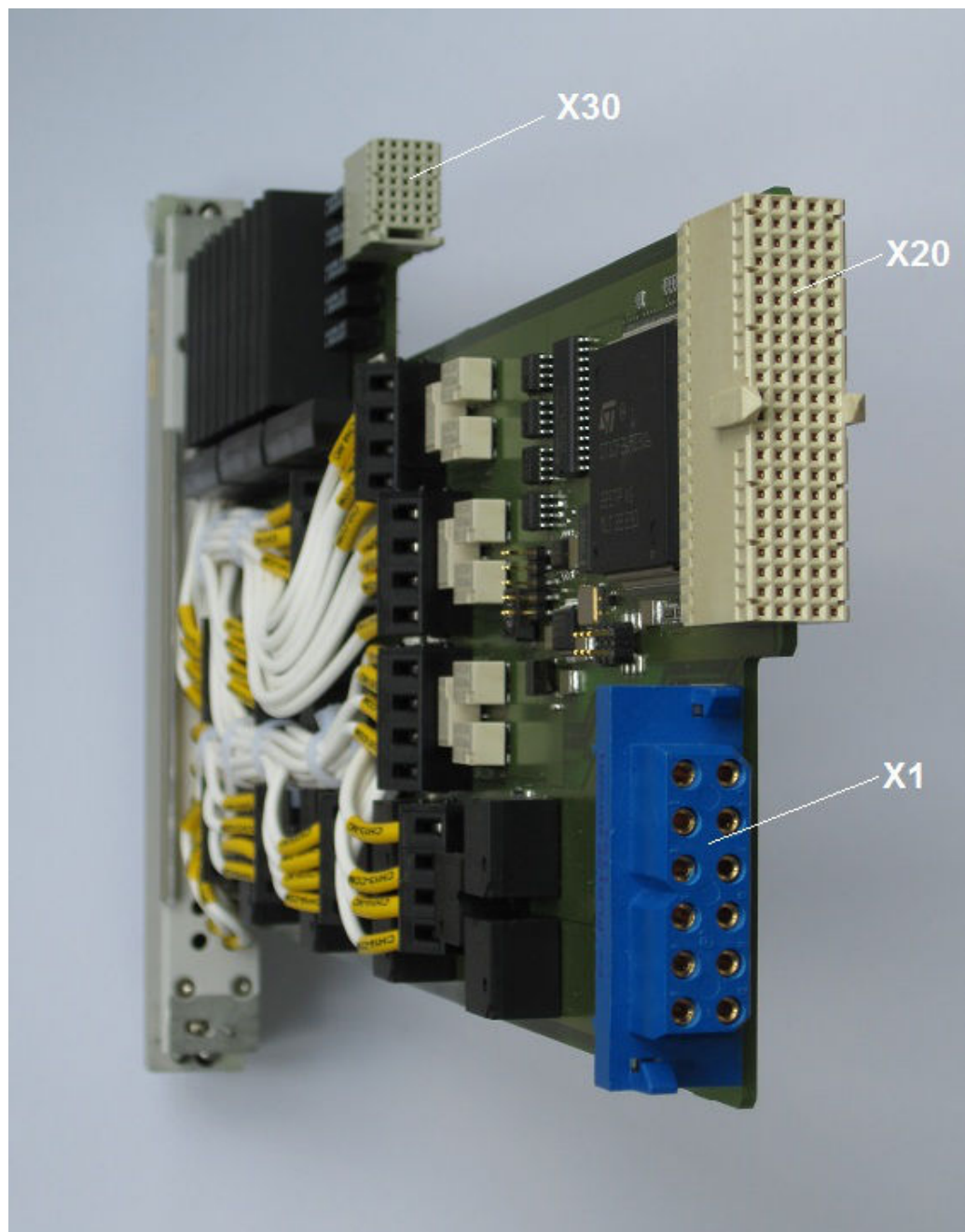

Figure 4-2: R&S TS-PSM4 Rear (to backplane of the chassis)

In contrast to the R&S TS-PSM4B (variant 02) the cabling of the connector (VPC) mounted on the front of the R&S TS-PSM4 (variant 03) with the appropriate terminals on the base board has already been done.

The designations of the terminals are given later in this document.

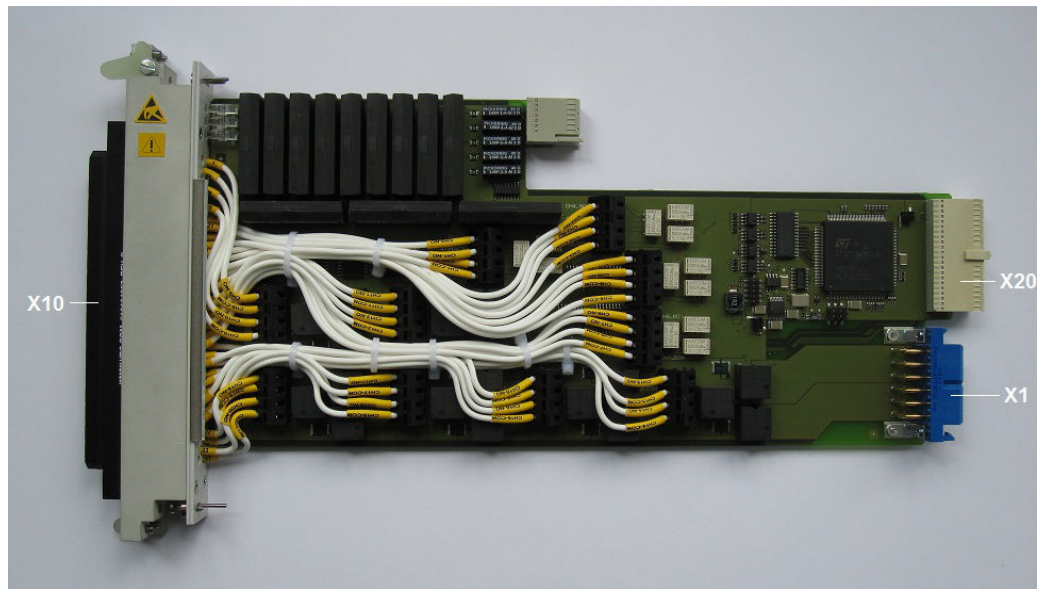

Figure 4-3: R&S TS-PSM4 (variant 03) Base board

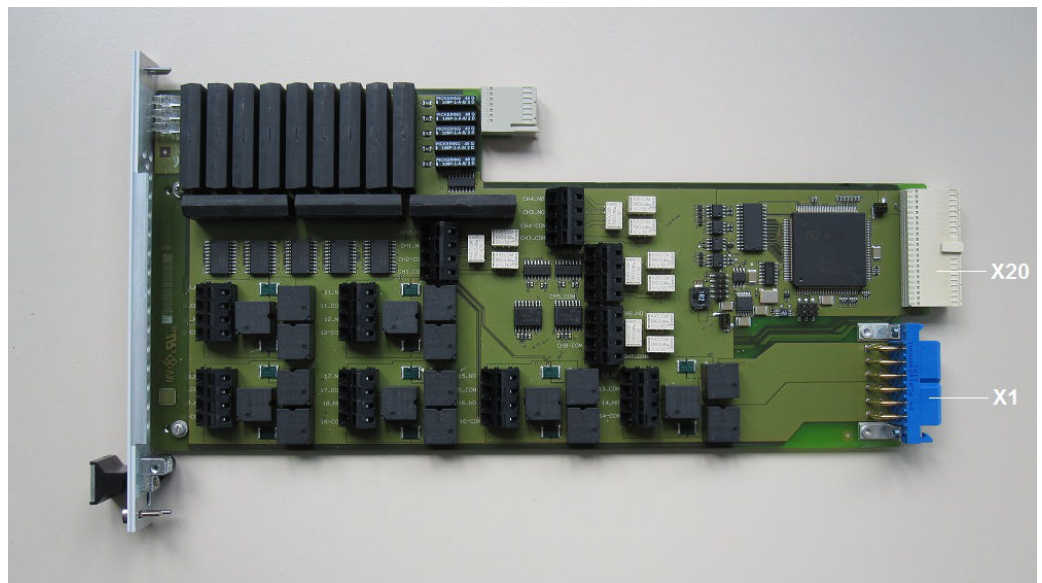

Figure 4-4: R&S TS-PSM4B (variant 02) Base board

4.1.2 Connectors

Table 4-1: Connectors on the R&S TS-PSM4

Abbreviation	Use
X1	Interface of channels 9 to 20 with optional R&S TS-PRIO2 Rear-I/O-Module for use in the R&S TS-PWA3, or for optional R&S TS-PK04 cable set for use in the R&S TS-PCA3.
X10	Interface to the DUT (only R&S TS-PSM4 (variant 03))
X20	Expansion (PXI, rear I/O). Interface of channels 1 to 8 with optional R&S TS-PRIO2 Rear-I/O-Module for use in the R&S TS-PWA3.
X30	TSVP analogue bus access for self-test and current measurement.

4.1.3 Display Elements

The front panel of the R&S TS-PSM4 contains three light-emitting diodes (LED's) with the following functions:

Table 4-2: Display elements on the R&S TS-PSM4

LED	Beschreibung
ERR (red)	Fault condition: Lights up when a fault is detected on the R&S TS-PSM4 in the power-on test after the supply voltage is switched on.
COM (yellow)	Communication: Lights up briefly when the R&S TS-PSM4 is accessed via the interface.
PWR (green)	Power: Lights up when all supply voltages are present.

LED Test:

When voltage is powered up all three LED's light up for around 1 second. This ensures that the 5 V supply is present and that the LED's and power-on test are functioning.

4.2 R&S TS-PRIO2

In the R&S TS-PWA3 chassis the optional R&S TS-PRIO2 Rear-I/OModule can be connected behind the R&S TS-PSM4 module. This way a feed-through of all channels of the R&S TS-PSM4 module to the rear of the R&S TS-PWA3 chassis can be achieved.

4.2.1 Mechanical construction

The R&S TS-PRIO2 Rear-I/O-Module consists of a board which holds the connectors X20 and X11 (to the R&S TS-PSM4) on the backplane side.

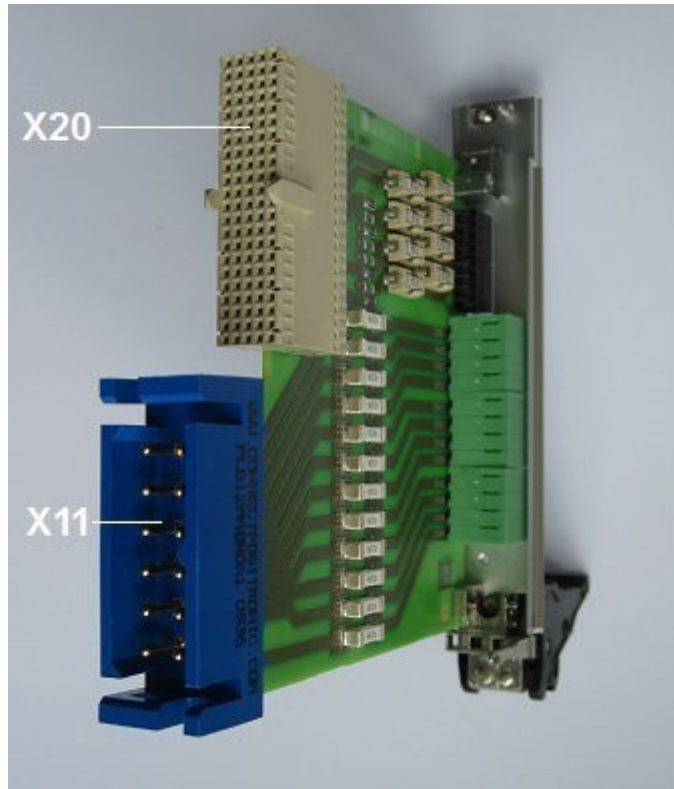

Figure 4-5: R&S TS-PRIO2 backplane side (to the R&S TS-PSM4)

The connectors X1 to X5 are located on the side accessible to the user (rear of the R&S TS-PWA3). Here loads or supply units can be connected to the low power and high power channels of the R&S TS-PSM4 module.

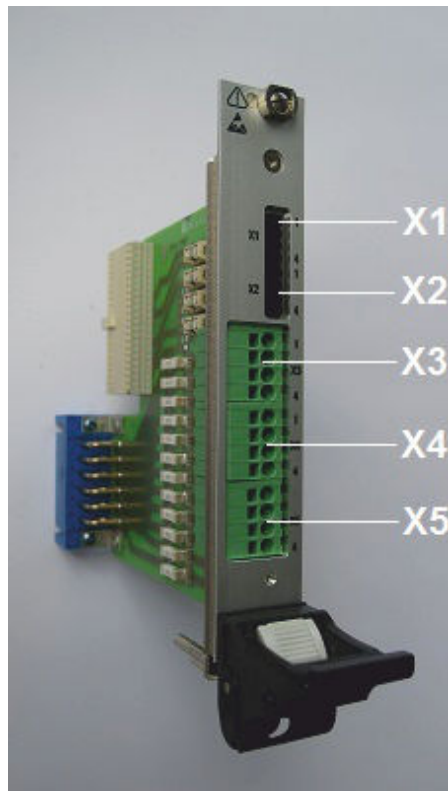

Figure 4-6: R&S TS-PRIO2 contact side (rear of R&S TS-PWA3 chassis)

For more information about the connectors X1 to X5 may be obtained from the manufacturer PHOENIX CONTACT.

The name of the connector X1 and X2 is:

PTSM 0.5/ 4-2.5-H THR R32 - 1770908

The name of the connector X3, X4 and X5 is:

SPT 1,5/ 4-H-3.5 - 1990753

In order to be able to connect a wire to the terminals the terminal's metal spring must first be pushed far enough, using a flat-head screwdriver to clear the opening that will take the wire. To do so a suitable screwdriver must be placed in the left-hand square opening of the terminal. The metal spring can be pushed to the right by a light lever action from left to right.

The connectors X1 and X2 can take wires with a maximum of 0.5 mm² cross-section surface, while the connectors X3, X4 and X5 are suitable for wires with a maximum of 1,5 mm² cross-section surface.

The low power channels are provided with interchangeable 3 A fuses on the R&S TS-PRIO2 Rear-I/O-Module. [Figure 4-7](#) shows the position of the fuses on the module.

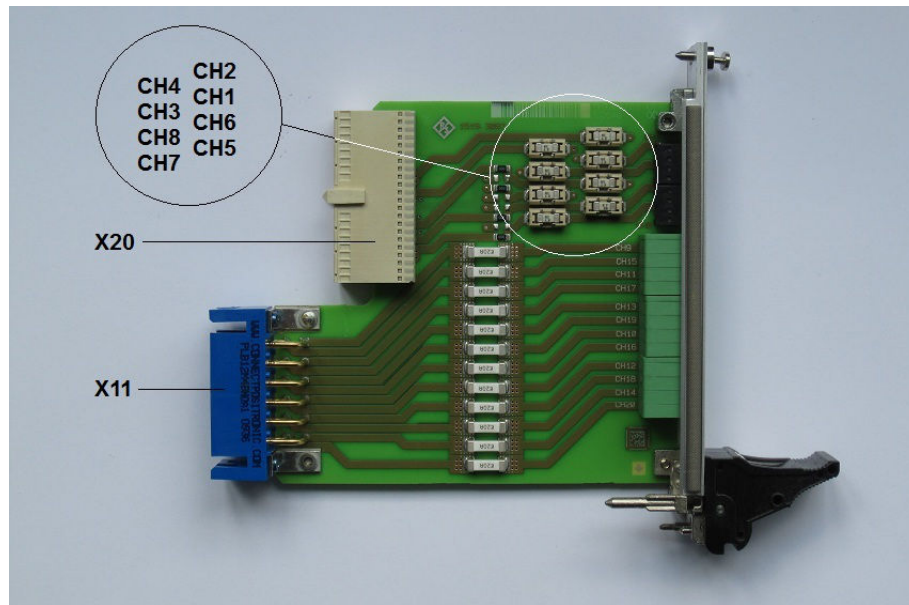

Figure 4-7: R&S TS-PRIO2 position of 3 A fuses

4.2.2 Connectors

Table 4-3: Connectors on the R&S TS-PRIO2

Abbreviation	Use
X11	Interface of channels 9 to 20 with the R&S TS-PSM4.
X1, X2	Interface of low power channels 1 to 8 with the load or voltage source.
X3, X4, X5	Interface of high power channels 9 to 20 with the load or voltage source.
X20	Interface of channels 1 to 8 with the R&S TS-PSM4.

4.3 R&S TS-PK04

If the optional R&S TS-PK04 cable set has been installed in the R&S TS-PCA3 or R&S TS-PWA3 chassis, the 16 A high current channels 9 to 20 and all 2 A channels of the R&S TS-PSM4 on the rear of the chassis will be made accessible via the connectors X3 and X4. For this purpose the R&S TS-PSM4 module must be installed in slot 16 in the chassis.

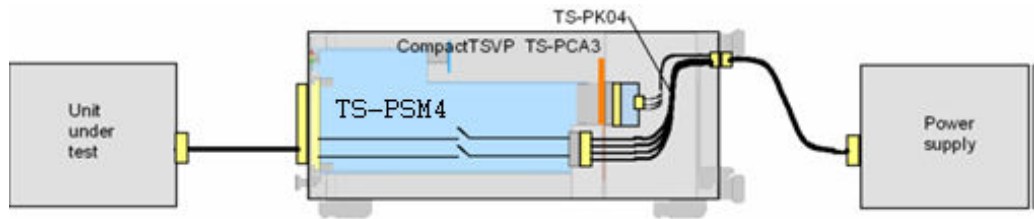

Figure 4-8: Installation of R&S TS-PSM4 with R&S TS-PK04 in the CompactTSVP R&S TS-PCA3

4.3.1 Mechanical construction

In Figure 4-9 the installation of the R&S TS-PK04 cable set in the CompactTSVP R&S TS-PCA3 (cTSVP) and its connections to the R&S TS-PSM4 (here shown in simplified form) is displayed.

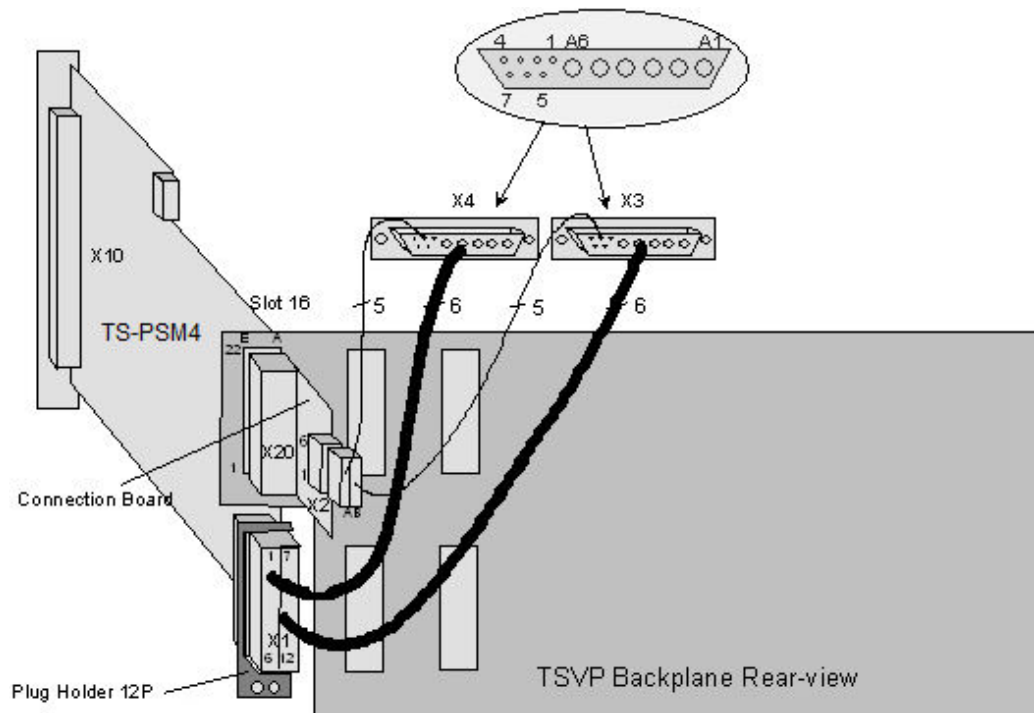

Figure 4-9: R&S TS-PK04 Installation in R&S TS-PCA3 (cTSVP)

4.3.2 Connectors

(see Figure 4-9)

Table 4-4: Connectors on R&S TS-PK04 cable set

Abbreviation	Use
X1	Interface of high power channels 9 to 20 with the R&S TS-PSM4.
X3 und X4	Interface of the high power channels 9 to 20 and low power channels 1 to 8 with the load or voltage source.
X20	Interface of low power channels 1 to 8 with the R&S TS-PSM4.

5 Functional description

5.1 R&S TS-PSM4

(see [Chapter 3, "Block diagram"](#), on page 6)

5.1.1 Signal concept

The power relays of all channels of the R&S TS-PSM4 can be wired up with power supplies or loads via the front of the module. In addition all channels can be routed to the rear of the R&S TS-PWA3 PowerTSVP chassis via the optional R&S TS-PRIO2 Rear-I/O-Module. In the R&S TS-PCA3 CompactTSVP chassis there is the option to route all low power channels and high power channels to the rear via the R&S TS-PK04 cable set.

Each channel can be used as a sense line or power line in order to create a connection between load and power supply unit.

The voltage drop corresponding to the current flow through each channel of the R&S TS-PSM4 can be measured via 22 mΩ shunt resistors on the low power channels and 5 mΩ shunt resistors on the high power channels via the chassis's analogue bus. The exact level of the shunt resistors is determined when calibrating the module. These values are used for calculating the actual current through the channel. The amount of current through a channel can be retrieved from the module via the IVI switch driver when the measured voltage level is specified.

The R&S TS-PSM4 (variant 03) can be ordered with a Virginia Panel Corp. (VPC) connector on the front of the module. The connector is connected to the individual channels of the module via terminals on the switch card using a pre-assembled cable set. In the R&S TS-PSM4B (variant 02) without VPC the user can connect his loads or power supply units with his own cables via apertures on the front plate of the module to the terminals of the channels.

More information about the terminals and cables required follow later in this document.

5.1.2 System Functions

The system functions are implemented by a local processor with internal Flash. There is also an external FRAM. The cycle counters of all relays on the R&S TS-PSM4 are located in the FRAM. The readings can be retrieved from the module via the IVI switch driver.

Communication with the system controller in the CompactTSVP or an external control computer is via the CAN bus.

The functions of the R&S TS-PSM4 can be summarized as follows:

- Analog function test

- Connection of voltage/current sources
- Connection of test component loads (original loads, simulated/electronic load)
- Switch simulation

5.1.3 Application examples

5.1.3.1 Measuring current during active load

A typical application example for the use of a R&S TS-PSM4 module is connection of a load to a voltage supply. In the example shown below (Figure 5-1) the voltage supply is connected to the COM lines on the rear of the R&S TS-PSM4. This can be done via the R&S TS-PRIO2 optionally installed in the R&S TS-PWA3 or the R&S TS-PK04 cable set in the TS-PCA3 chassis. The load is connected to the NO lines located on the front of the R&S TS-PSM4. The voltage supply's force lines are introduced to the load via two 16 A high power channels, whereas the sense lines are run via 2 A low power channels.

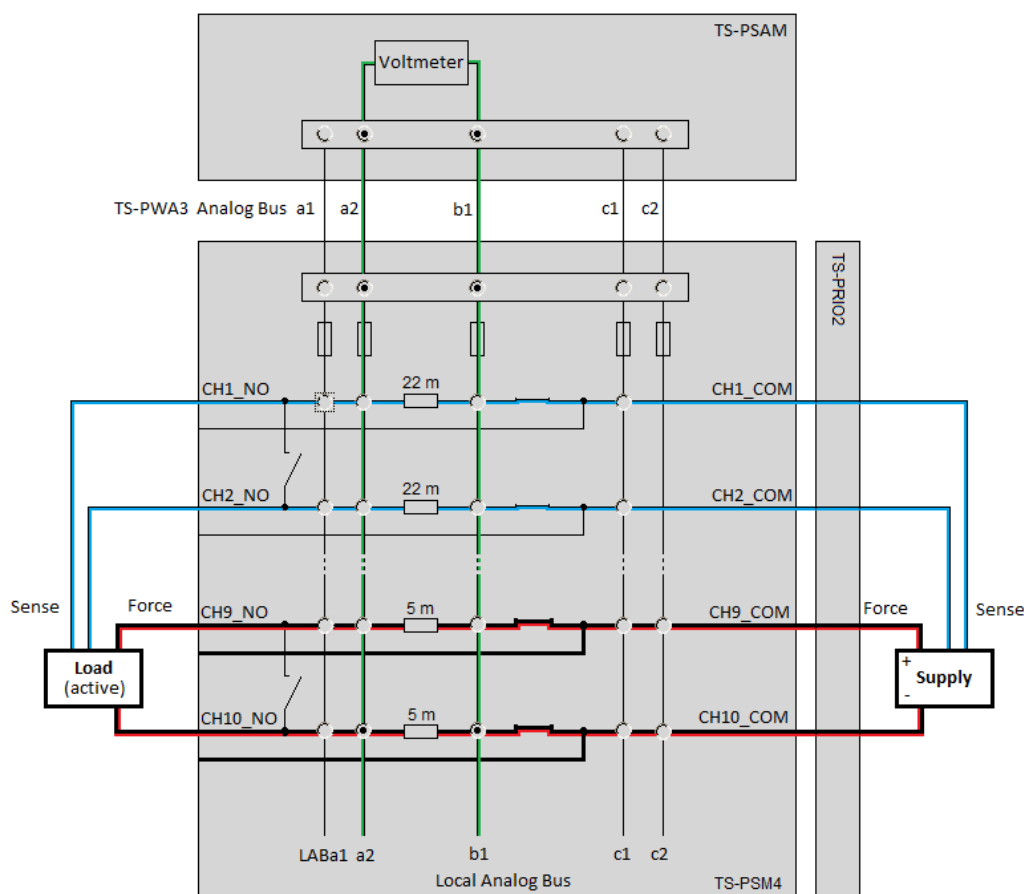

Figure 5-1: Application example - measuring current with active load

The relatively high current, which in the load's switched on active state flows through the high power channels, can be determined via a 5 mΩ shunt resistor. The voltage drop at the shunt resistor is conducted via the R&S TS-PSM4's matrix- or coupling relays to the analogue bus of the R&S TS-PWA3 chassis and from there to, for example, the R&S TS-PSAM measurement module. The measurement module's voltmeter ascertains the voltage. Via the `rpsm4_GetCalculatedCurrent` function of the IVI software driver that is part of the R&S TS-PSM4, the current belonging to this voltage level can be retrieved. It is calculated via correction values stored on the module. See also the programming example later on in this document.

The current paths are coloured red in the diagram above, the lines with sense voltage are blue and the paths over which the voltage drop on the shunt resistor is measured are coloured green.

5.1.3.2 Current measurement with load in standby mode

If now the small amount of residual current through the load is to be determined, if the latter is in standby mode, another version of the switching is chosen.

Small currents up to one ampere can be measured directly from the R&S TS-PSAM module's ammeter. If the current measurement gives a value via the high power channel's shunt resistor that is less than or equal to 1 A, then the switching as shown in [Figure 5-2](#) can be used for the current measurement. With the channel 9 high power relay opened, the entire current is conducted via matrix- and coupling relays on the R&S TS-PWA3's analogue bus and from there to the ampere meter of the R&S TS-PSAM's measurement module. These lines are coloured red.

⚠ CAUTION

The analogue bus lines of the R&S CompactTSVP and R&S PowerTSVP are designed for a maximum current strength of 1 A.

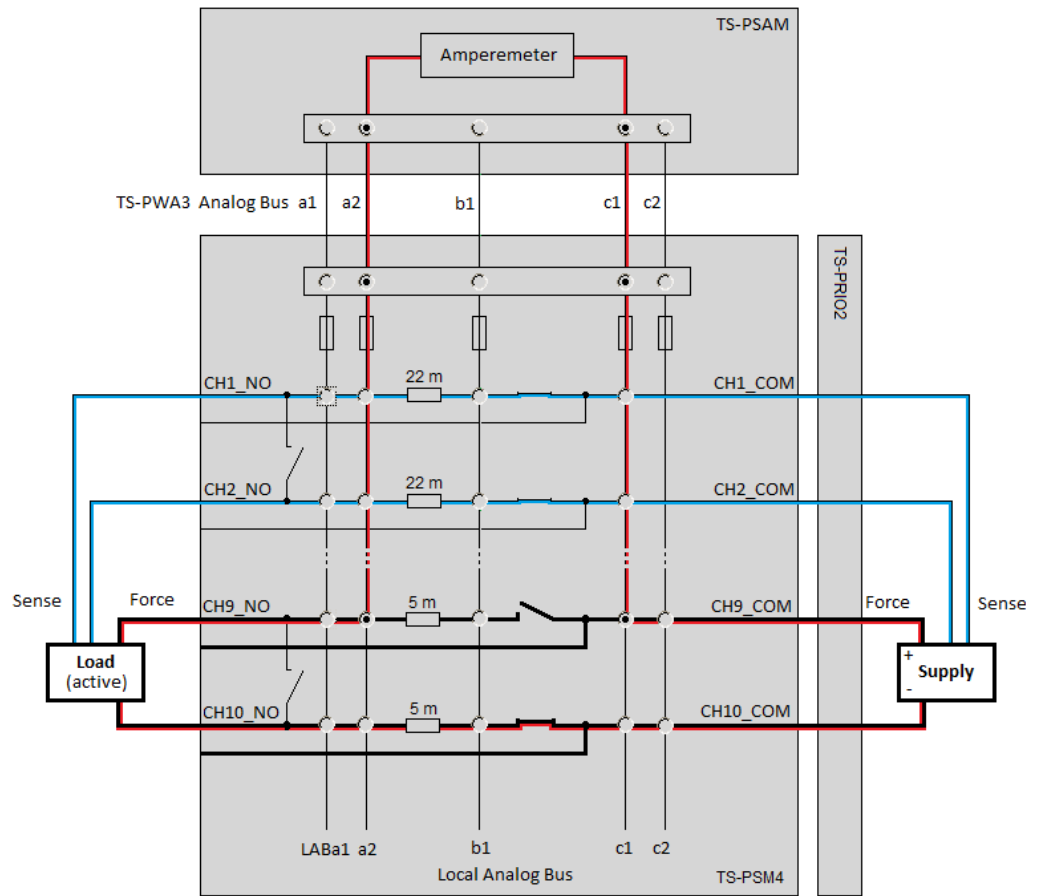

Figure 5-2: Application example - current measurement with load in standby mode

6 Setting up

6.1 Channel wiring of the R&S TS-PSM4B (variant 02)

In contrast to the completely cabled R&S TS-PSM4 (variant 03) with mounted VPC connector, the R&S TS-PSM4B (variant 02) is supplied without channel wiring and with simple front plate. In this version the user can himself carry out the wiring of the channels that he needs. For this purpose suitable wires are run from the terminals of the individual channels on the module's base board via the module's front plate openings outward to a load or power source.

6.1.1 Position of the connecting terminals

Figure 6-1 shows the position of the connecting terminals on the base board.

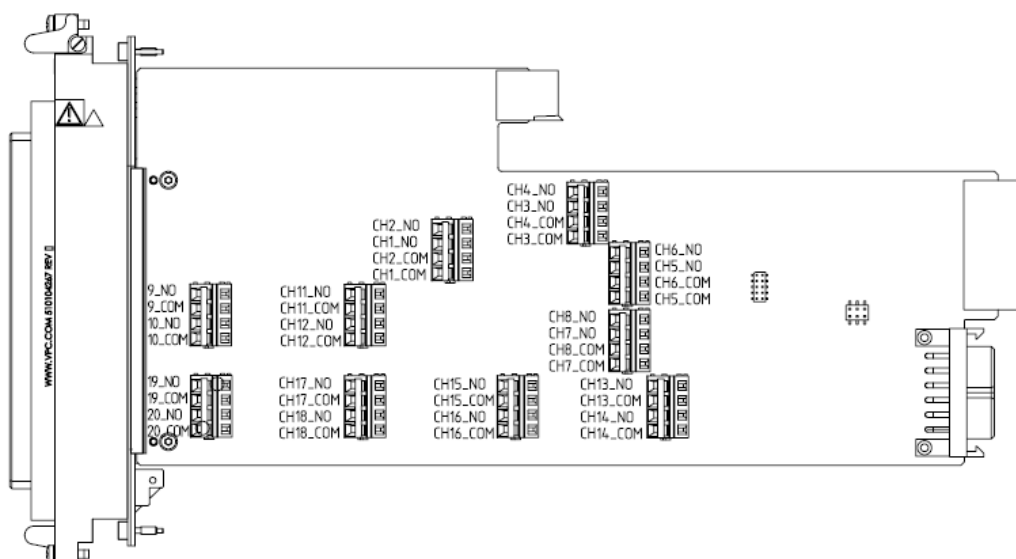

Figure 6-1: Position of the connecting terminals on the base board

6.1.2 Mounting the terminal wires (high power channels)

(see Figure 6-2 to Figure 6-5)

In order to be able to connect a wire to terminals of low power or high power channels, the terminal's metal spring must first be pushed far enough, using a flat-head screwdriver, to clear the opening that will take the wire. To do so the screwdriver must be placed in the upper square opening of the terminal. The metal spring can be pressed down by a light lever action and the screwdriver pushed into the terminal as far as it will go.

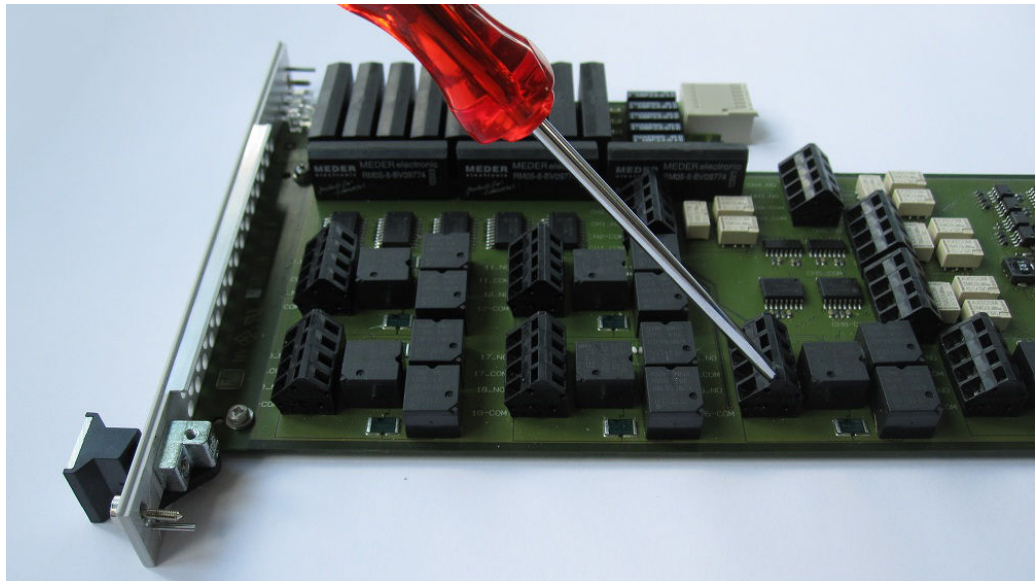

Figure 6-2: Opening the terminal contact CH16_COM

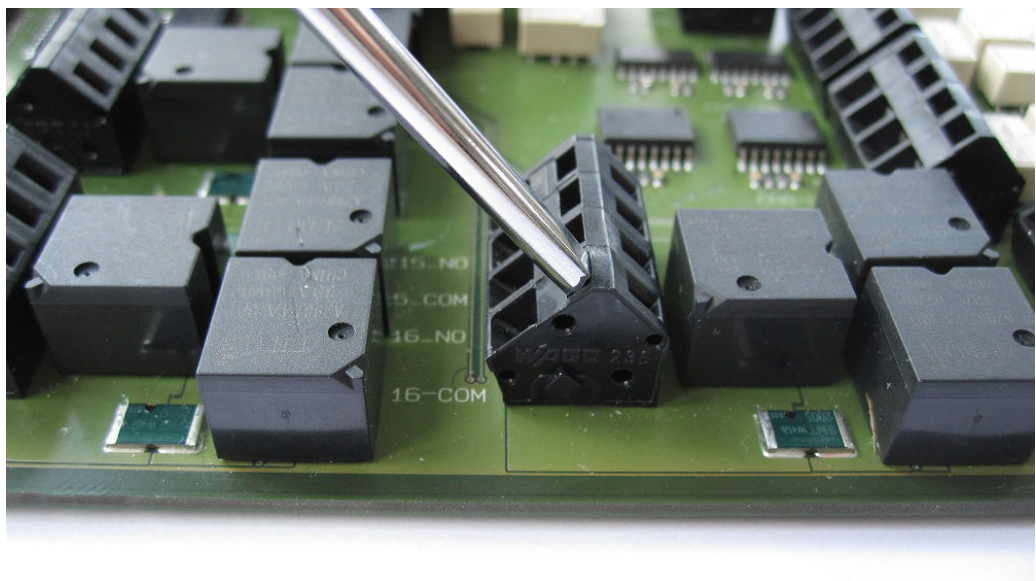

Figure 6-3: Over the upper opening of the terminal the metal spring can be pressed down

The wire to be mounted is now inserted into the exposed lower opening. To establish a good connection the wire must be free of its insulation by a length of about 6 mm. After removing the screwdriver from the upper opening the metal spring will spring back and clamp the inserted wire firmly and form a good connection with low contact resistance.

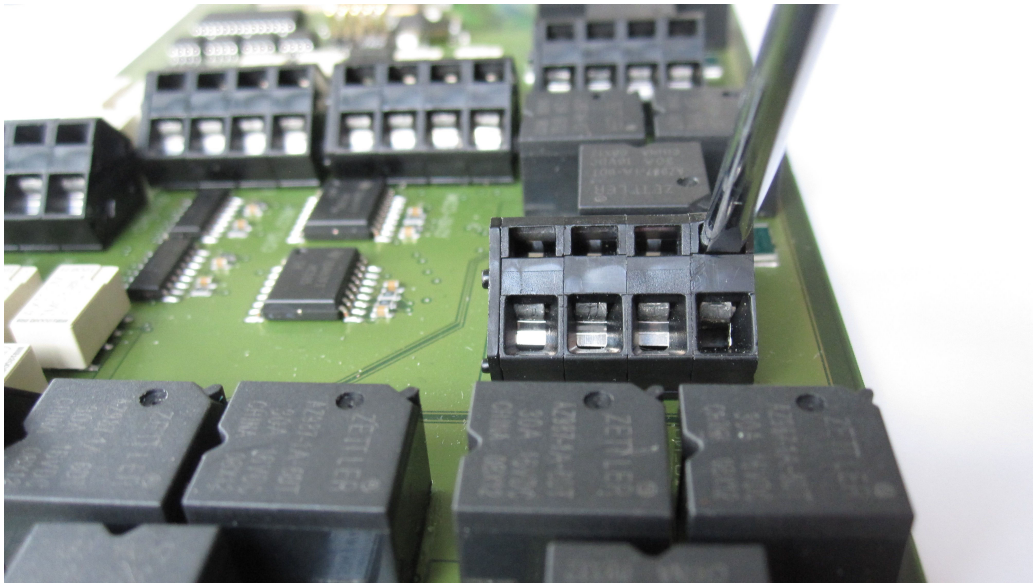

Figure 6-4: The wire can be mounted in the lower round opening

As an example of a complete wiring here the wiring of the R&S TS-PSM4 (variant 03) is shown:

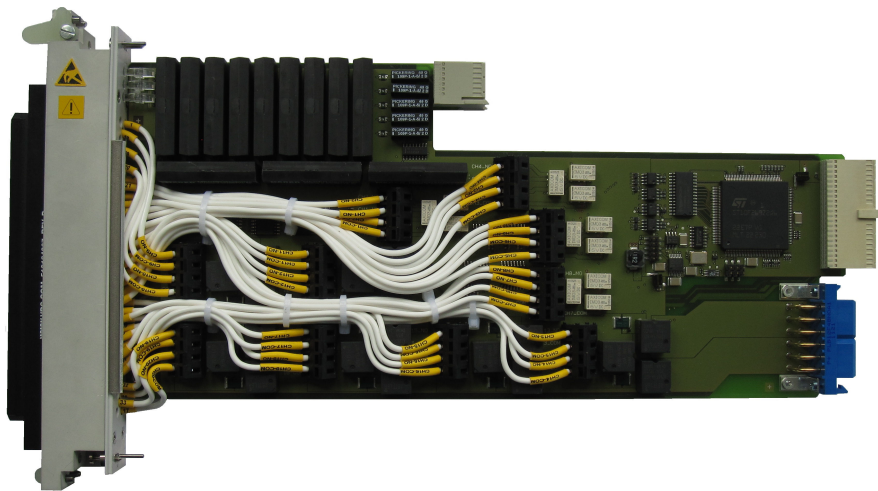

Figure 6-5: R&S TS-PSM4 (variant 03)

In the identical terminals of the high-power and low-power channels of the R&S TS-PSM4 (variant 03) wires labelled AWG 14 are finely stranded. The wires are each mounted without ferrules in the terminals.

Table 6-1: Specification of wires

AWG	d (mm)	A (mm ²)	R (Ω/km)
14	1,63	2,08	8,55

More information on this terminal can be obtained from the manufacturer WAGO.

The terminal is labelled as follows:

Serie 236 THR (5 mm / 0.08 - 2,5 mm²),

Order no.: 236-404/334-604

6.2 Installation of the R&S TS-PSM4

NOTICE

Damaged backplane due to bent pins

Bent pins may result in permanent damage to the backplane.

Check the backplane connector for bent pins!

Any pins that are bent must be straightened!

When module is connected, it must be guided with both hands and carefully pressed into the backplane connector.

To install the High-Power Switch Module R&S TS-PSM4 , proceed as follows:

1. Shut down and switch off the R&S TS-PCA3 CompactTSVP or the PowerTSVP R&S TS-PWA3.
2. Select an appropriate front slot. The R&S TS-PSM4 requires one slot. See also "CompactTSVP operating manual" / "PowerTSVP operating manual", section "Permissible module configurations" .
3. Remove the corresponding front plate section on the CompactTSVP housing by undoing the screws.
4. Insert the R&S TS-PSM4 with moderate pressure
5. The top pilot pin of the R&S TS-PSM4 must be guided into the right-hand hole, the bottom one into the left-hand hole on the CompactTSVP housing.
6. The R&S TS-PSM4 is correctly inserted if a definite stop can be felt.
7. Tighten the screws on the top and bottom of the front plate of the R&S TS-PSM4.

6.2.1 Installation of the R&S TS-PSM4 in the CompactTSVP R&S TS-PCA3

For installation in the CompactTSVP R&S TS-PCA3 slots 5 to 16 are allowed, although in most cases it only makes sense to operate in slots 15 or 16. In slots 5 to 14 the R&S TS-PSM4 can only be operated if a R&S TS-PRIO or R&S TS-PRIO4 module is present on the corresponding rear slot of the TSVP with version 4.0 of the backplane. This is the only way that the R&S TS-PSM4 can be connected to the necessary power sup-

ply in these slots. In the CompactTSVP it is not possible to use the R&S TS-PRIO2 in a rear slot.

In slots 15 and 16 of the CompactTSVP R&S TS-PCA3 the voltage supply of the R&S TS-PSM4 is guaranteed even without R&S TS-PRIO(4) module via the X20 connector. In slot 16 all low power and high power channels 9 to 20 can be run via the optional R&S TS-PK04 cable set even to the rear of the CompactTSVP R&S TS-PCA3 to connectors X3 and X4.

6.2.2 Installation of the R&S TS-PSM4 in the PowerTSVP R&S TS-PWA3

Slots 1 to 16 are permitted for installation in the PowerTSVP R&S TSPWA3. The voltage supply for the R&S TS-PSM4 is guaranteed on all slots in the PowerTSVP R&S TS-PWA3 even without a R&S TS-PRIO module attached to the rear. Optionally the R&S TS-PRIO2 module can be placed in rear slots 1 to 14. With this module all low power and high power channels on the rear of the PowerTSVP R&S TS-PWA3 can be made accessible. If the R&S TS-PSM4 is operated in slot 16, there is the capability for both CompactTSVP R&S TS-PCA3 and PowerTSVP R&S TS-PWA3 to run all low power and high power channels 9 to 20 to the X3 and X4 connectors on the rear of the unit via the optional R&S TS-PK04 cable set.

NOTICE

Installation in slot 1 must be carried out with the utmost care, as components on the underneath of the R&S TS-PSM4 can be damaged via contact with the adjacent power supply unit. It must be ensured that after the installation there are no points of contact between the HF seal of the power supply unit, which may be warped, and the R&S TS-PSM4. For safety reasons it is recommended that slot 1 in the PowerTSVP R&S TS-PWA3 may not be used for the R&S TS-PSM4.

6.3 Installation of the R&S TS-PRIO2



The R&S TS-PRIO2 can only be mounted in the PowerTSVP R&S TS-PWA3. Installation in the CompactTSVP R&S TS-PCA3 is not possible.

NOTICE**Damaged backplane due to bent pins**

Bent pins may result in permanent damage to the backplane.

Check the backplane connector for bent pins!

Any pins that are bent must be straightened!

When module is connected, it must be guided with both hands and carefully pressed into the backplane connector.

Proceed as follows to install the R&S TS-PRIO2:

1. Shut down and switch off the PowerTSVP R&S TS-PWA3.
2. Select an appropriate rear slot. The R&S TS-PRIO2 requires one slot.
See also "PowerTSVP operating manual", section "Permissible module configurations" .
3. Select an appropriate Rear-I/O-Slot to the R&S TS-PSM4.
4. Loosen the screws and remove the appropriate front plate section from the PowerTSVP chassis.

7 Software

7.1 Driver Software

A LabWindows IVI driver that supports the class IVI SWITCH is available to control the High-Power Switch Module R&S TS-PSM4. All additional functions of the hardware are supported by specific extensions of the driver. The driver is a component of the ROHDE & SCHWARZ GTSL software. All functions of the driver are documented extensively in online Help and in the LabWindows/CVI Function Panels.

During driver installation, the following software modules are installed:

Table 7-1: Driver Installation R&S TS-PSM4

Module	Path	Comment
rpspm4.dll	<GTSL directory>\Bin	Driver
rpspm4.hlp / rpspm4.chm	<GTSL directory>\Bin	Help files
rpspm4.fp	<GTSL directory>\Bin	LabWindows CVI Function Panel file, function panels for CVI development interface
rpspm4.sub	<GTSL directory>\Bin	LabWindows CVI attribute file. This file is required by some „function panels“.
rpspm4.lib	<GTSL directory>\Bin	Import Library
rpspm4.h	<GTSL directory>\ Include	Header file for the driver



To use the driver, the IVI and VISA libraries from National Instruments are necessary.

7.2 Softpanel

The software package of the R&S TS-PSM4 includes a so-called softpanel. The soft-panel enables interactive operation of the module.

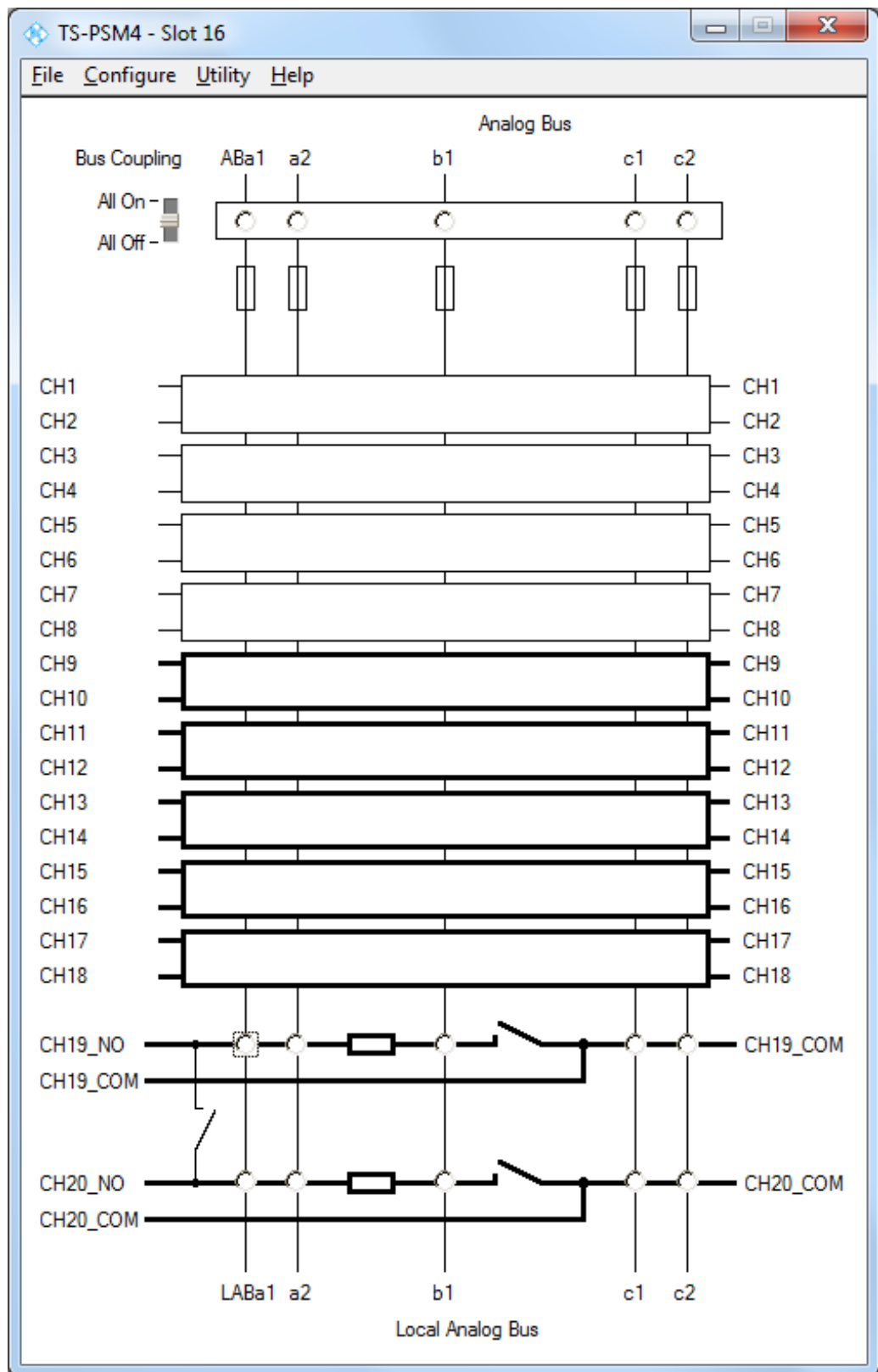

Figure 7-1: Softpanel R&S TS-PSM4

7.3 Programming with GTSL Libraries

```
/*
This example connects an external power supply to a load via TS-PSM4
channels 9 and 10. The power supply is connected to CH9_COM and
CH10_COM at the rear of the module TS-PSM4 and the load is connected
to CH9_NO and CH10_NO at the front of the module. The sense-lines of
the power supply are routed to the load via TS-PSM4 channels 1 and 2.
The current through channel 10 is determined indirectly by measuring
the voltage at the 5 mOhms shunt resistor of channel 10.
Later on, the load is set to standby mode and the low standby current
is measured directly via the ampere meter of TS-PSAM. Therefore
the power relay of channel 9 is opened and the standby current is
bypassed via matrix relays to the analog bus and TS-PSAM module.
```

Error handling is not considered in this sample in order to keep it easy to read. The return status should be checked for "errorOccurred" after each library call.

The following configuration files are used in this example:

physical.ini

```
[device->PSM4]
Description = "TS-PSM4 Module in Frame 1 Slot 16"
Type        = PSM4
ResourceDesc = CAN0::0::1::16
Frame       = 1
Slot        = 16
DriverDll   = rspsm4.dll
DriverPrefix = rspsm4
DriverOption = "Simulate=0,RangeCheck=1"
SFTDll     = sftmpsm4.dll
SFTPrefix   = SFTMPSM4

[device->PSAM]
Description = "TS-PSAM Module in Frame 1 Slot 8"
Type        = PSAM
ResourceDesc = PXI3::10::INSTR
Frame       = 1
Slot        = 8
DriverDll   = rspsam.dll
DriverPrefix = rspsam
DriverOption = "Simulate=0,RangeCheck=1"
RioType     = PDC
; Note: the self test DLL and prefix keywords must be removed for the
```

```

;      first TS-PSAM module, because it is already tested in the
;      basic self test.
; SFTD11      = sftmpsam.dll
; SFTPrefix   = SFTMPSAM

; Analog bus pseudo-device, used by ROUTE, SWMGR and EGTSL
[device->ABUS]
Type          = AB

        application.ini
        -----

[bench->psm4SampleApp]
Simulation    = 0
Trace        = 1

DigitalMultimeter = device->PSAM

SwitchDevice1    = device->PSAM
SwitchDevice2    = device->PSM4

; The analog bus is a "virtual" device for the switch manager.
; It allows connections between measurement and switch modules.
AnalogBus       = device->ABUS

; Channel tables
AppChannelTable = io_channel->psm4SampleApp

;-----
; The application channel table lists all logical channel names for the
; in-circuit-test, switch manager and the routing library.
;-----
[io_channel->psm4SampleApp]

DMM_HI          = PSAM!DMM_HI
DMM_LO          = PSAM!DMM_LO
PSM4_CH1_NO     = PSM4!CH1_NO
PSM4_CH1_COM    = PSM4!CH1_COM
PSM4_CH2_NO     = PSM4!CH2_NO
PSM4_CH2_COM    = PSM4!CH2_COM
PSM4_CH9_NO     = PSM4!CH9_NO
PSM4_CH9_COM    = PSM4!CH9_COM
PSM4_CH10_NO    = PSM4!CH10_NO
PSM4_CH10_COM   = PSM4!CH10_COM
*/

```

```

#include <ansi_c.h>
#include <userint.h>

#include "resmgr.h"
#include "route.h"
#include "dmm.h"
#include "rspsm4.h"

int main (int argc, char *argv[])
{

    long    residRoute; /* resource ID for signal routing library */
    long    residDmm;   /* resource ID for dmm library          */

    short   errorOccurred = 0;
    long    errorCode = 0;
    char    errorMessage [GTSL_ERROR_BUFFER_SIZE] = "";

    double  voltageResult = 0.0;
    double  currentResultLoadActive = 0.0;
    double  currentResultLoadStandby = 0.0;
    int     resultsCount = 0;

    ViSession psm4SessionHandle = -1;

    /* load the physical and application configuration files */

    RESMGR_Setup ( 0, "physical.ini", "application.ini",
                  &errorOccurred, &errorCode, errorMessage);

    /* initialize the signal routing library */
    ROUTE_Setup ( 0, "bench->psm4SampleApp", &residRoute,
                  &errorOccurred, &errorCode, errorMessage);

    /* initialize the dmm library */
    DMM_Setup ( 0, "bench->psm4SampleApp", &residDmm,
                &errorOccurred, &errorCode, errorMessage);

    /* close coupling relays to TS-PCA3 Analog Bus */
    DMM_Conf_Coupling_Relays ( 0, residDmm, 1,
                               &errorOccurred, &errorCode, errorMessage);

    /* set dmm function, resolution and auto ranging */
    DMM_Conf_Measurement ( 0, residDmm, "DC_VOLTS", 0.0, "AUTO_RANGE_ON",
                           1.0e-4,
                           &errorOccurred, &errorCode, errorMessage);

```

```

/* connect DMM_HI and DMM_LO to local analog bus lines a2 and b1 */
ROUTE_Execute ( 0, residRoute, "DMM_HI > $LABa2, DMM_LO > $LABb1",
                &errorOccurred, &errorCode, errorMessage);

/* connect the 5 mOhms shunt resistor of TS-PSM4 channel 10 to
   analog bus line a2 und b1 */
ROUTE_Execute ( 0, residRoute, "PSM4_CH10_NO > $LABa2 > $ABa2,
                                PSM4_CH10_NO > $LABb1 > $ABb1",
                                &errorOccurred, &errorCode, errorMessage);

/* close low-power-relays of TS-PSM4 channel 1 and channel 2 to route
   the sense-lines of the power supply to the load */
ROUTE_Execute ( 0, residRoute, "PSM4_CH1_NO > PSM4_CH1_COM, PSM4_CH2_NO
                                > PSM4_CH2_COM",
                                &errorOccurred, &errorCode, errorMessage);

/* close high-power-relays of TS-PSM4 channel 9 and channel 10;
   wait for debounce for all switch modules */
ROUTE_Execute ( 0, residRoute, "PSM4_CH9_NO > PSM4_CH9_COM,
                                PSM4_CH10_NO > PSM4_CH10_COM, ?#",
                                &errorOccurred, &errorCode, errorMessage);

/* measure voltage at 5 mOhms shunt resistor of TS-PSM4 channel 10
*/
DMM_Read ( 0, residDmm, 1.0, 1, &voltageResult, &resultsCount,
           &errorOccurred, &errorCode, errorMessage);

/* Get the TS-PSM4 ivi-switch-driver session handle which is needed to
   call driver functions */
RESMGR_Get_Session_Handle (0, residRoute, "SwitchDevice2",
                           &psm4SessionHandle,
                           &errorOccurred, &errorCode, errorMessage);

/* get the current value which corresponds to the measured voltage
   value at TS-PSM4 channel 10 */
rpsm4_GetCalculatedCurrent ( psm4SessionHandle, "CH10",
                             voltageResult,
                             &currentResultLoadActive );

MessagePopup( "User Activity", "Please switch off the load.\n---\n"
              "The load is now in standby mode." );

/* measure voltage at 5 mOhms shunt resistor of TS-PSM4 channel 10;
   make sure it is below 1 A */
DMM_Read ( 0, residDmm, 1.0, 1, &voltageResult, &resultsCount,
           &errorOccurred, &errorCode, errorMessage);

```

```

/* get the current value which corresponds to the measured voltage
   value at TS-PSM4 channel 10 */
rpsm4_GetCalculatedCurrent ( psm4SessionHandle, "CH10",
                             voltageResult,
                             &currentResultLoadStandby );

if( currentResultLoadStandby < 1.0 )
{
    /*
       the current through the load is lower than 1 ampere - we can switch
       the current directly to the ampere meter of the TS-PSAM module
       to perform a more sensitive measurement of the standby current
    */

    /* disconnect DMM_HI and DMM_LO from local analog bus lines a2 and
       b1 */
    ROUTE_Execute ( 0, residRoute, "DMM_HI | $LABa2, DMM_LO | $LABb1",
                   &errorOccurred, &errorCode, errorMessage);

    /* disconnect the 5 mOhms shunt resistor of TS-PSM4 channel 10
       from analog bus line a2 and b1 */
    ROUTE_Execute ( 0, residRoute, "PSM4_CH10_NO | $LABa2 | $ABa2,
                                   PSM4_CH10_NO | $LABb1 | $ABb1",
                   &errorOccurred, &errorCode, errorMessage);

    /* set dmm function, resolution and auto ranging */
    DMM_Conf_Measurement ( 0, residDmm, "DC_CURRENT", 0.0,
                          "AUTO_RANGE_ON", 1.0e-4,
                          &errorOccurred, &errorCode, errorMessage);

    /* connect DMM_LO to local analog bus line a2 and DMM_HI to analog
       bus line c1 */
    ROUTE_Execute ( 0, residRoute, "DMM_LO > $LABa2, DMM_HI > $LABc1",
                   &errorOccurred, &errorCode, errorMessage);

    /* bypass the high-power-relay and current-voltage-converter of
       TS-PSM4 channel 9 with the ampere meter of TS-PSAM */
    ROUTE_Execute ( 0, residRoute, "PSM4_CH9_COM > $LABc1 > $ABc1,
                                   PSM4_CH9_NO > $LABa2 > $ABa2",
                   &errorOccurred, &errorCode, errorMessage);

    /* open the high-power relay on TS-PSM4 channel 9;
       wait for debounce for all switch modules */
    ROUTE_Execute ( 0, residRoute, "PSM4_CH9_NO | PSM4_CH9_COM, ?#",
                   &errorOccurred, &errorCode, errorMessage);

    /* measure the current through the ampere meter of TS-PSAM */
    DMM_Read ( 0, residDmm, 1.0, 1, &currentResultLoadStandby,
              &resultsCount,

```



```
        &errorOccurred, &errorCode, errorMessage);
    }

    /* disconnect all existing connections */
    ROUTE_Execute ( 0, residRoute, "||",
        &errorOccurred, &errorCode, errorMessage);

    /* close the libraries */
    DMM_Cleanup (0, residDmm, &errorOccurred, &errorCode, errorMessage);

    ROUTE_Cleanup (0, residRoute, &errorOccurred, &errorCode,
        errorMessage);

    RESMGR_Cleanup (0, &errorOccurred, &errorCode, errorMessage);

    {
        char buffer[100];
        sprintf( buffer, "Load Active Current: %.3f A\n"
            "Load Standby Current: %.3f A",
            currentResultLoadActive, currentResultLoadStandby);
        MessagePopup( "User Information", buffer );
    }

    return(0);
}
```

8 Self-test

The R&S TS-PSM4 has a built-in self-test capability. The following tests are implemented:

- LED-Test
- Power-on test
- TSVP Self-Test

8.1 LED Test

After power-on, all three LED's light up for around three seconds to indicate that the 5 V supply is present and all LED's are working. The following statements can be made about the different LED states:

Table 8-1: Statements about the LED Test

LED	Description
One LED does not light up	Hardware problem on the module LED faulty
No LED's light up	No +5 V supply

8.2 Startup test

The startup test runs in parallel with the LED test. The following information can be drawn from the different LED display states.

Table 8-2: Startup test observations

LED	Description
PWR LED (green) on	all power supplies present
PWR LED (green) off	at least one power supply voltage is missing
ERR LED (red) off	If the green LED is switched on at the same time, there is no identifiable error
ERR LED (red) on or flashing	Hardware error

8.3 TSVP self-test

As part of the TSVP self-test a comprehensive test of the module R&S TS-PSM4 is carried out and a detailed report generated. This is done via the „Self-Test Support Library“.

The R&S TS-PSAM analogue source and measurement module is used as a measurement unit in the TSVP self-test. The functionality of the modules in the system is ensured by measurements via the analogue measurement bus.



For information on starting the self-test and the order of required work steps, please consult the GTSL Software Description or the GTSL online Help. A detailed description of the parameters and sequences tested may be found in the R&S Compact TSVP / R&S Power TSVP Service Manual.

9 Interface description

9.1 R&S TS-PSM4

9.1.1 Connector X1

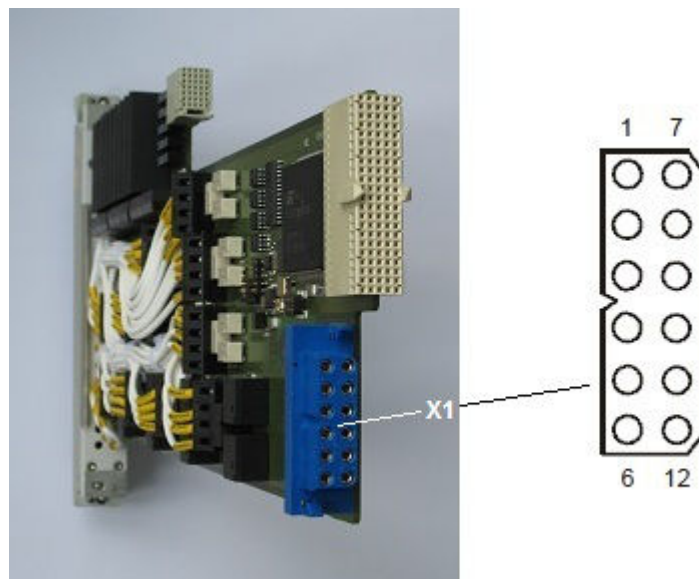

Figure 9-1: R&S TS-PSM4 connector X1 (view: plug side)

Table 9-1: R&S TS-PSM4 connector X1 assignment

Pin	Channel	Pin	Channel
1	CH9_COM	7	CH15_COM
2	CH11_COM	8	CH17_COM
3	CH13_COM	9	CH19_COM
4	CH10_COM	10	CH16_COM
5	CH12_COM	11	CH18_COM
6	CH14_COM	12	CH20_COM

9.1.2 Connector X10 (only R&S TS-PSM4 (variant 03))

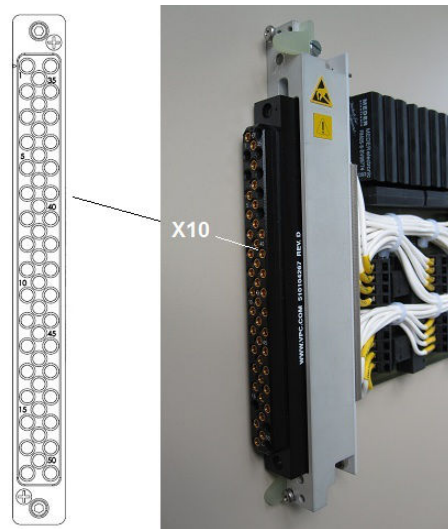

Figure 9-2: R&S TS-PSM4 (variant 03) connector X10

Table 9-2: R&S TS-PSM4 (variant 03) connector X10 assignment

Pin	Channel	Pin	Channel	Pin	Channel
1	CH9_NO	18	CH9_COM	34	
2		19	CH10_NO	35	
3		20	CH10_COM	36	
4	CH2_NO	21	CH1_NO	37	
5	CH2_COM	22	CH1_COM	38	
6	CH3_NO	23	CH3_COM	39	CH4_NO
7	CH4_COM	24	CH6_NO	40	CH6_COM
8	CH5_NO	25	CH11_NO	41	CH5_COM
9	CH8_COM	26	CH12_NO	42	CH11_COM
10	CH7_NO	27	CH8_NO	43	CH12_COM
11	CH13_COM	28	CH13_NO	44	CH7_COM
12	CH14_COM	29	CH14_NO	45	CH15_COM
13	CH18_COM	30	CH18_NO	46	CH16_COM
14	CH17_COM	31	CH17_NO	47	CH15_NO
15		32	CH19_NO	48	CH16_NO
16	CH19_COM	33	CH20_NO	49	
17	CH20_COM			50	

9.1.3 Connector X20

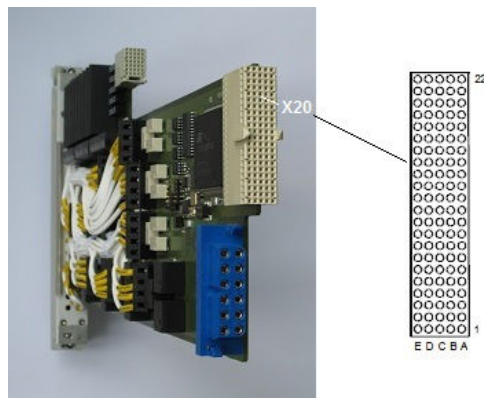

Figure 9-3: R&S TS-PSM4 connector X20 (view: plug side)

Pin	E	D	C	B	A
22	GA0	GA1	GA2	GA3	GA4
21				GA5	
20	+5V	GND	+5V		
19			+5V	GND	
18		CAN_EN			
17				GND	
16		GND			
15		+5V		GND	
14					
13					
12	CH4_COM				CH2_COM
11					
10	CH3_COM				CH1_COM
9					
8	CH6_COM				CH8_COM
7					
6	CH5_COM				CH7_COM
5					
4					
3	RSA0	RRST#		GND	RSDO
2		RSDI	RSA1		RSCLK
1	+5V	CAN_L	CAN_H	GND	RCS#

Figure 9-4: R&S TS-PSM4 connector X20 assignment

9.1.4 Connector X30

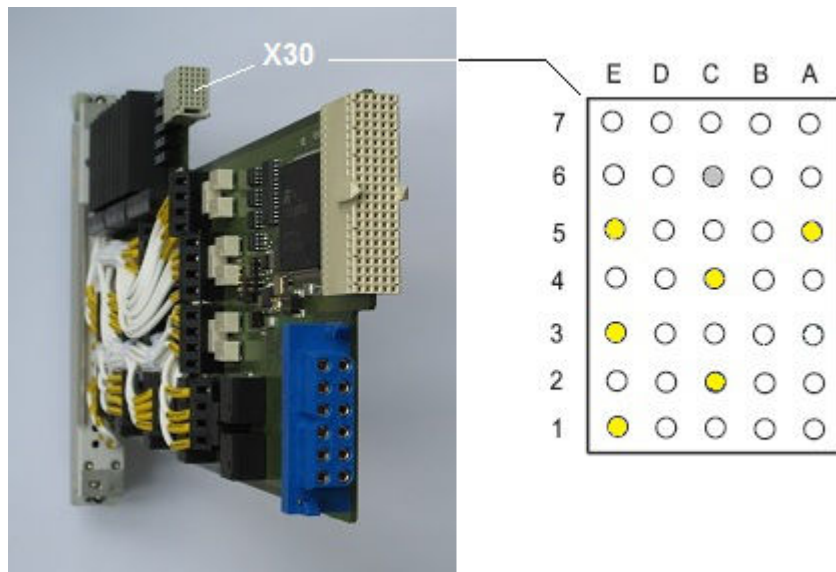

Figure 9-5: R&S TS-PSM4 connector X30 (view: plug side)

Pin	E	D	C	B	A
7					
6			GND		
5	ABc1				ABa1
4			ABb1		
3	ABc2				
2			ABa2		
1	ABd2				

Figure 9-6: R&S TS-PSM4 connector X30 assignment

9.2 R&S TS-PRI02

9.2.1 Connector X11

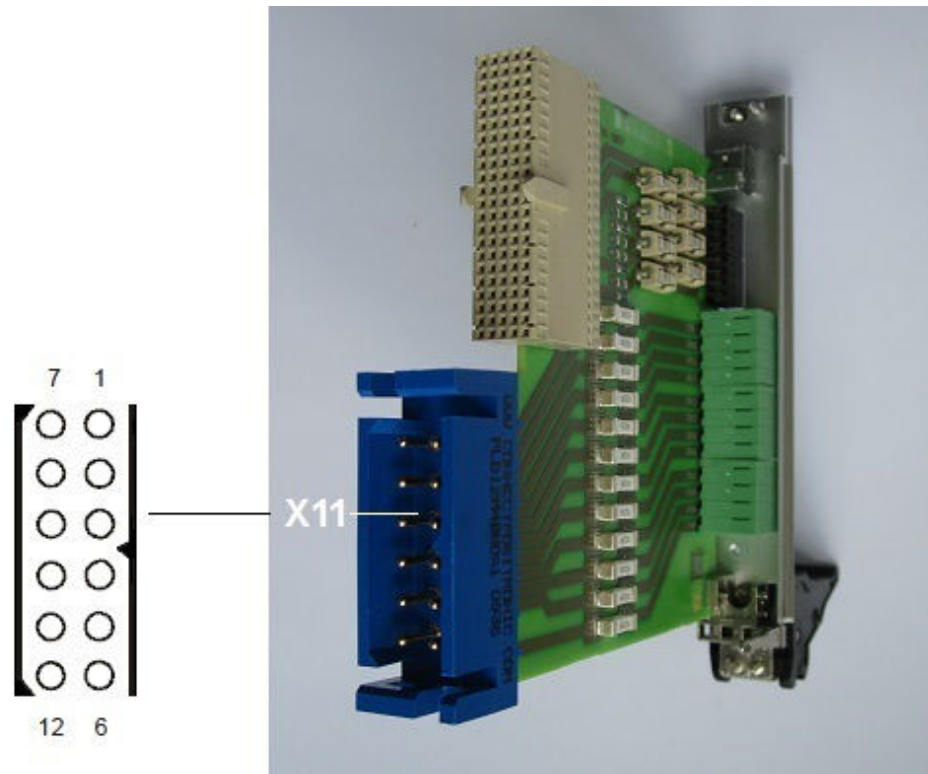

Figure 9-7: R&S TS-PRI02 connector X11 (view: plug side)

Table 9-3: R&S TS-PRI02 connector X11 assignment

Pin	Channel	Pin	Channel
7	CH15_COM	1	CH9_COM
8	CH17_COM	2	CH11_COM
9	CH19_COM	3	CH13_COM
10	CH16_COM	4	CH10_COM
11	CH18_COM	5	CH12_COM
12	CH20_COM	6	CH14_COM

9.2.2 Connector X20

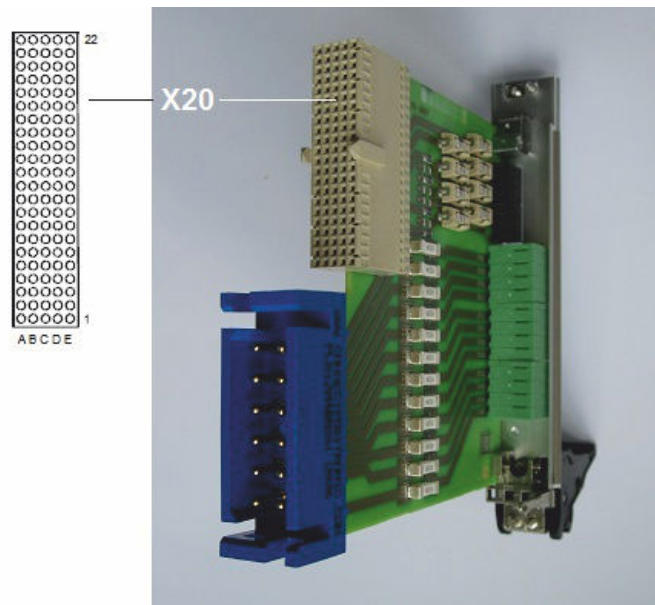

Figure 9-8: R&S TS-PRIO2 connector X20 (view: plug side)

Pin	A	B	C	D	E
22					
21					
20					
19					
18					
17					
16					
15					
14					
13					
12	CH2_COM				CH4_COM
11					
10	CH1_COM				CH3_COM
9					
8	CH8_COM				CH6_COM
7					
6	CH7_COM				CH5_COM
5					
4					
3					
2					
1					

Figure 9-9: R&S TS-PRIO2 connector X20 assignment

9.2.3 Connector X1 and X2

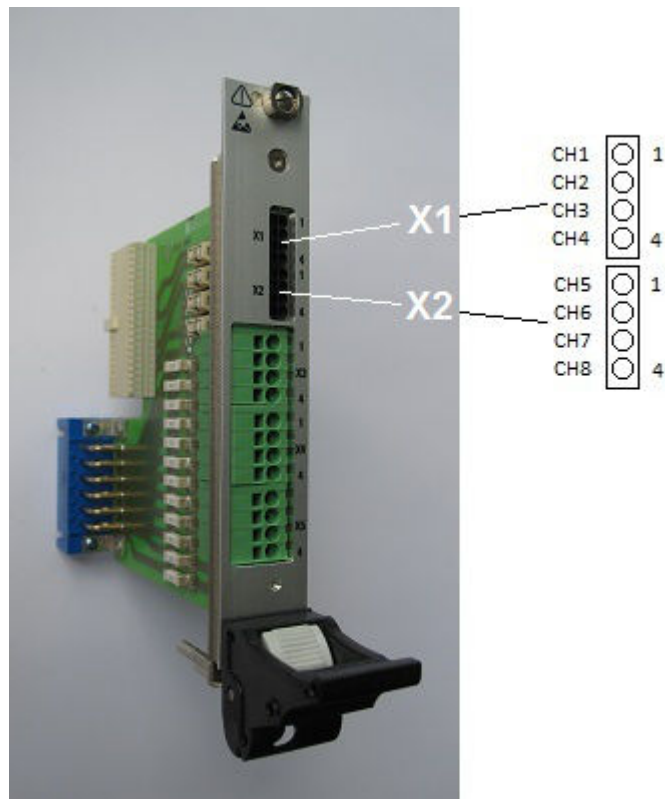

Figure 9-10: R&S TS-PRI02 connector X1 and X2

Table 9-4: R&S TS-PRI02 connector X1 and X2 assignment

X1	Pin	Channel	X2	Pin	Channel
	1	CH1_COM		1	CH5_COM
	2	CH2_COM		2	CH6_COM
	3	CH3_COM		3	CH7_COM
	4	CH4_COM		4	CH8_COM

9.2.4 Connector X3, X4 and X5

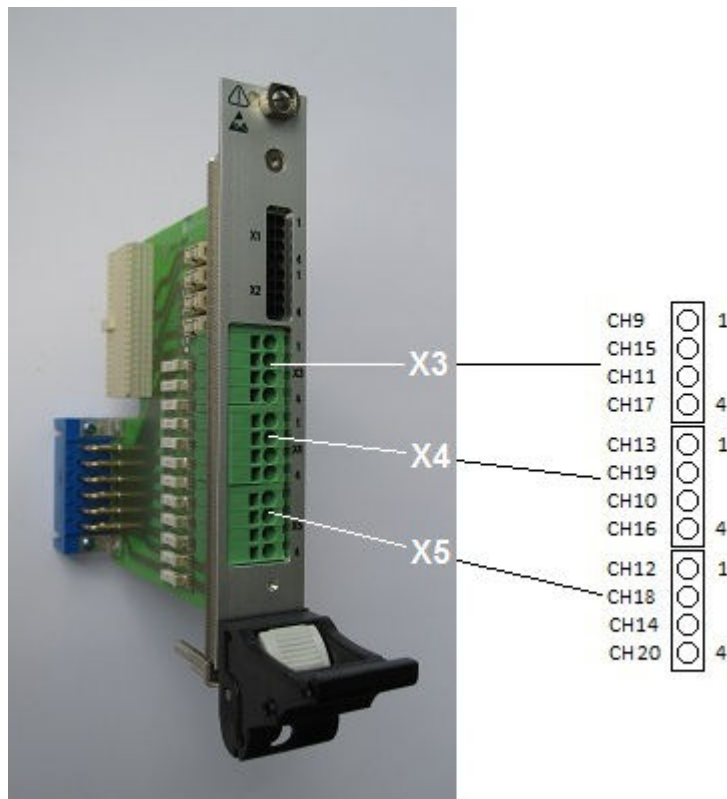

Figure 9-11: R&S TS-PRIO2 connector X3, X4 and X5

Table 9-5: R&S TS-PRIO2 connector X3, X4 and X5

X3	Pin	Channel	X4	Pin	Channel	X5	Pin	Channel
	1	CH9_COM		1	CH13_COM		1	CH12_COM
	2	CH15_COM		2	CH19_COM		2	CH18_COM
	3	CH11_COM		3	CH10_COM		3	CH14_COM
	4	CH17_COM		4	CH16_COM		4	CH20_COM

9.3 R&S TS-PK04

9.3.1 Connector X3

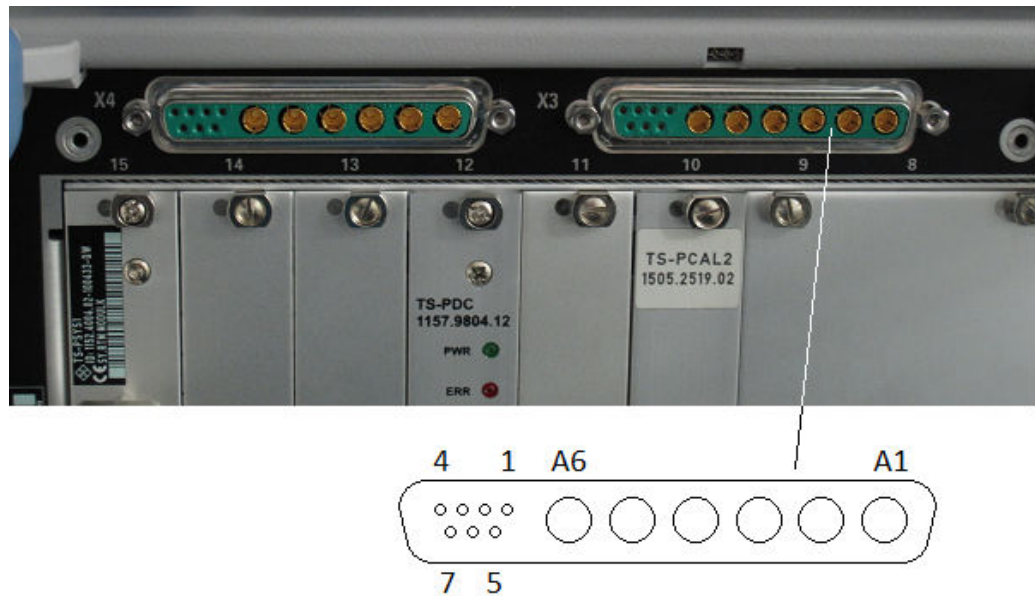

Figure 9-12: Connector X3 - rear of R&S TS-PCA3 or R&S TS-PWA3

Table 9-6: Connector X3 assignment

Pin	Channel	Pin	Channel
A1	CH15_COM	1	CH4_COM
A2	CH11_COM	2	CH3_COM
A3	CH13_COM	3	CH6_COM
A4	CH19_COM	4	CH5_COM
A5	CH9_COM	5	--
A6	CH10_COM	6	--
		7	--

9.3.2 Connector X4

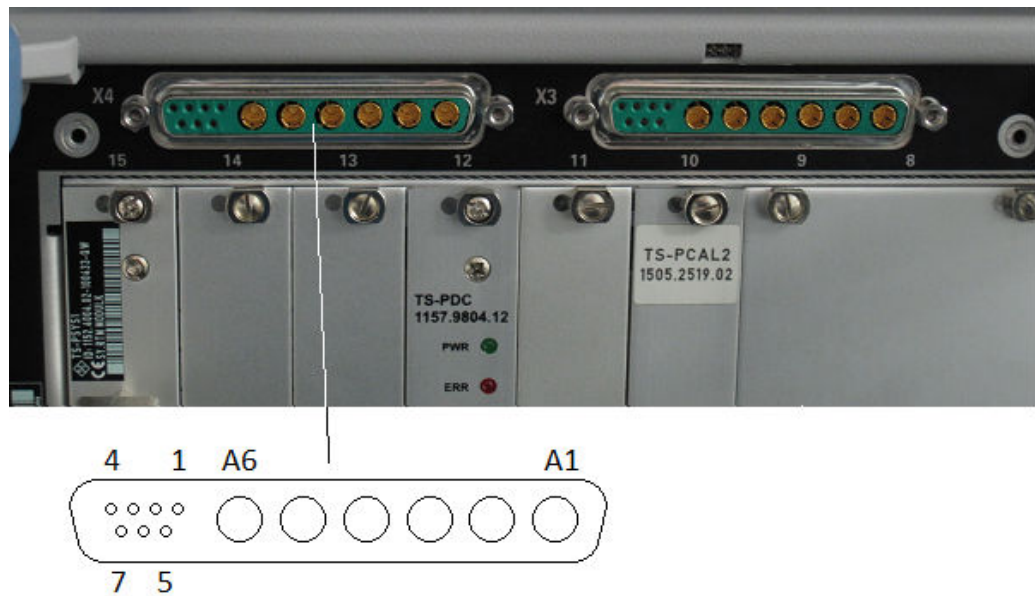

Figure 9-13: Connector X4 - rear of R&S TS-PCA3 or R&S TS-PWA3

Table 9-7: Connector X4 assignment

Pin	Channel	Pin	Channel
A1	CH12_COM	1	CH2_COM
A2	CH17_COM	2	CH1_COM
A3	CH18_COM	3	CH8_COM
A4	CH14_COM	4	CH7_COM
A5	CH20_COM	5	--
A6	CH16_COM	6	--
		7	--

10 Specifications

NOTICE

The technical data of the High-Power Switch Module R&S TS-PSM4 are shown in the corresponding data sheets.

In the event of any discrepancies between data in this user manual and technical data in the data sheet, the data sheet takes precedence.
